

**ARMY TM 5-617  
NAVY NAVFAC MO-113  
AIR FORCE AFM 91-31  
MARINE CORPS MCO P11014.9**

---

**FACILITIES ENGINEERING**

**MAINTENANCE  
AND  
REPAIR OF ROOFS**

---

DEPARTMENTS OF THE ARMY, THE NAVY, THE AIR FORCE,  
AND THE MARINE CORPS

JANUARY 1974

## FOREWORD

This manual prescribes the policy, criteria, and procedures for maintaining and repairing roofs at military installations. The principal causes of roof failures are discussed and measures are recommended for correcting problems for various types of roofing.

The maintenance standards prescribed have been established to protect Government property with an economical and effective expenditure of maintenance funds commensurate with the functional requirements and the planned future use of the facilities. The technical procedures outlined herein were developed from the best sources available in industry, the National Bureau of Standards, and the Military Departments.

The publication furnishes guidance for the maintenance forces in the field who will do the work and is designed for use in the performance of their work. The use of the systems and procedures described in this publication by personnel who have the responsibility for project preparation and supervision, specifications, procurement, inspection, storage, issue, application, and safety, should assure uniform, economical, and satisfactory roof maintenance and repair.

Advice concerning any procedure outlined in this manual may be obtained from:

*a.* Department of the Army, Office of the Chief of Engineers, ATTN: DAEN-MCF-B, Washington, D.C. 20314.

*b.* Department of the Navy, Naval Facilities Engineering Command (1013) Washington, D.C. 20390 or from its geographic Engineering Field Division.

*c.* Department of the Air Force, Directorate of Civil Engineering, ATTN: AF/PREES, Washington, D.C. 20332.

Recommendations or suggestions for modification, or additional information and instructions are invited that will improve this publication and motivate its use. Appropriate communication should be submitted through channels to the addressees listed above.

## **ACKNOWLEDGMENT**

The courtesy of the Asphalt Roofing Manufacturers Association in permitting free use of 4 illustrations (figures 29, 32, 33 and 34) from their publication entitled "Manufacture, Selection, and Application of Asphalt Roofing and Siding Products" is hereby acknowledged.

TECHNICAL MANUAL  
NO. 5-617  
NAVY PUBLICATION  
NAVFAC MO-113  
AIR FORCE MANUAL  
AFM 91-31  
MARINE CORPS  
MANUAL  
MCO P11014.9



DEPARTMENTS OF THE ARMY,  
THE NAVY, THE AIR FORCE  
AND THE MARINE CORPS

WASHINGTON, D.C. 30 January 1974

## FACILITIES ENGINEERING

### MAINTENANCE AND REPAIR OF ROOFS

		Paragraph	Page
CHAPTER	1. INTRODUCTION		
Section	I. General		
	Purpose .....	1.1.1	1
	Scope .....	1.1.2	1
	References .....	1.1.3	1
	Painting .....	1.1.4	1
	Fire classification of roof coverings for military construction .....	1.1.5	1
	Manufacturers' instructions .....	1.1.6	1
	Use of accepted materials .....	1.1.7	1
	Structural problems .....	1.1.8	1
	Method of accomplishing work .....	1.1.9	1
	Access to roofs .....	1.1.10	2
	Equipment on roofs .....	1.1.11	2
	Use of construction guide specifications .....	1.1.12	2
	Roofing colors .....	1.1.13	2
	II. Army Responsibility		
	General .....	1.2.1	2
	Criteria, standards and procedures .....	1.2.2	2
	III. Navy Responsibility		
	Naval Facilities Engineering Command .....	1.3.1	2
	Commanding Officer .....	1.3.2	2
	Public Works Center/Public Works Department .....	1.3.3	2
	IV. Air Force Responsibility		
	Directives .....	1.4.1	8
	Headquarters, USAF level .....	1.4.2	8
	Major Command level .....	1.4.3	8
	Base Commander level .....	1.4.4	8
CHAPTER	2. GENERAL DISCUSSION		
	Importance of periodic inspections .....	2.1.1	4
	Importance of special inspections .....	2.1.2	4
	Importance of contract inspections .....	2.1.3	4
	Maintenance .....	2.1.4	5
	Repairs .....	2.1.5	5
	Reroofing .....	2.1.6	5
	Research on roofing .....	2.1.7	5
CHAPTER	3. CAUSES OF ROOF FAILURES		
	Lack of maintenance .....	3.1.1	6
	Weathering .....	3.1.2	6
	Use of unseasoned lumber or improper grade plywood .....	3.1.3	6

\* This manual supersedes TM 5-617, 2 June 1945, NAVDOCKS MO-113, September 1963, and AFM 85-4, Part D, October 1957.

		Paragraph	Page
CHAPTER	3.	Improper storage .....	3.1.4 6
		Improper application of materials .....	3.1.5 6
		Use of improper materials .....	3.1.6 9
		Wind damage .....	3.1.7 12
		Exposed nails .....	3.1.8 12
		Failure of flashings .....	3.1.9 12
		Improper design .....	3.1.10 13
	4.	BUILT-UP ROOFING	
Section	I.	Description and General Discussion	
		General .....	4.1.1 14
		Slope .....	4.1.2 14
		Bitumen .....	4.1.3 14
		Felts .....	4.1.4 14
		Aggregate-surfaced roofs .....	4.1.5 15
		Smooth-surfaced roofs .....	4.1.6 15
		Insulation .....	4.1.7 16
		Vapor barrier .....	4.1.8 17
		Venting .....	4.1.9 17
		Fastenings .....	4.1.10 17
		Roof drainage .....	4.1.11 17
		Designation .....	4.1.12 17
	II.	Roof Decks for Built-up Roofs	
		Wood decks .....	4.2.1 17
		Poured concrete and gypsum decks .....	4.2.2 18
		Precast concrete units .....	4.2.3 15
		Precast gypsum units .....	4.2.4 18
		Steel decks .....	4.2.5 18
	II.	Storage, Handling, and Application of Materials	
		Weather conditions .....	4.3.1 18
		Asphalt and coal-tar pitch .....	4.3.2 18
		Felts .....	4.3.3 19
		Surfacing .....	4.3.4 19
		Insulation and underlayment .....	4.3.5 20
		Vapor barriers .....	4.3.6 21
	IV.	Determining Treatment for Built-up Roofs .....	----- 21
	V.	Maintenance Methods for Built-up Roofs (Treatment prior to failure)	
		General .....	4.5.1 21
		Maintenance of aggregate-surface~ built-up roofs (Treatment prior to failure) .....	4.5.2 21
		Maintenance of smooth-surfaced roofs (Treatment prior to failure) .....	4.5.3 22
	VI.	Repair Methods for Built-up Roofs (Treatment following at least partial failure)	
		Aggregate-surfaced, built-up roofs .....	4.6.1 25
		Smooth-surfaced asphalt, built-up roofs .....	4.6.2 29
	VII.	Reroofing	
		General .....	4.7.1 29
		Specifications .....	4.7.2 29
		Drawings .....	4.7.3 29
		Preparation of deck for reroofing .....	4.7.4 29
		Corrective measures .....	4.7.5 30
CHAPTER	5.	ASPHALT SHINGLE ROOFING	
Section	1.	Description and General Discussion	
		References .....	5.1.1 31
		General description .....	5.1.2 31
		Coverage .....	5.1.3 31
		Weight .....	5.1.4 31
		Headlap .....	5.1.5 31
		Exposure .....	5.1.6 31
		Fire Resistance .....	5.1.7 31
		Square-butt strip shingles .....	5.1.8 32
		Wind-resistant shingles .....	5.1.9 32
	II.	Roof Decks for Asphalt-Shingle Roofs .....	----- 33
	III.	Storage and Handling Asphalt Shingles	
		Handling shingles .....	5.3.1 33
		Storage of shingles .....	5.3.2 33

		Paragraph	Page
CHAPTER	5. (Continued)		
Section	IV. Determining Treatment for Asphalt-Shingle Roofs		
	Weathering .....	5.4.1	33
	Clawed shingles .....	5.4.2	33
	Recoating .....	5.4.3	34
	V. Maintenance and Repair Methods for Asphalt-Shingle Roofs		
	Maintaining roofs having improperly nailed shingles .....	5.5.1	36
	Maintaining asphalt-shingled roofs in areas of strong winds .....	5.5.2	36
	Maintaining asphalt-shingled roofs damaged by hail .....	5.5.3	36
	Renewing rotted eaves boards .....	5.5.4	37
	Installing drip edge at rake .....	5.5.5	37
	VI. Reroofing With Asphalt Shingles		
	General .....	5.6.1	39
	Preparing deck for reroofing with asphalt shingles .....	5.6.2	39
	Applying asphalt-shingle roof .....	5.6.3	39
CHAPTER	6. ASPHALT ROLL ROOFING		
Section	I. Description and General Discussion		
	General .....	6.1.1	41
	Smooth-surfaced .....	6.1.2	41
	Mineral-surfaced .....	6.1.3	41
	Fire resistance rating .....	6.4	43
	II. Roof Decks for Asphalt Roll Roofing Roofs .....	-----	43
	III. Storage and Handling Asphalt Roll Roofing .....	-----	43
	IV. Determining Treatment for Asphalt Roll Roofing Roofs Leaking seams .....	6.4.1	43
	Smooth-surfaced .....	6.4.2	43
	Mineral-surfaced .....	6.4.3	43
	V. Maintenance Methods-Asphalt Roll Roofing		
	Recoating smooth-surfaced roll roofings .....	6.5.1	43
	Recoating mineral-surfaced roll roofings .....	6.5.2	44
	VI. Repair Methods-Asphalt Roll Roofings		
	Small breaks .....	6.6.1	44
	Large breaks .....	6.6.2	44
	Large areas .....	6.6.3	45
	Repairing leaky seams of roll roofing .....	6.6.4	45
	VII. Storage and Handling of Metal Roofing .....	-----	46
CHAPTER	7. ASBESTOS-CEMENT ROOFING		
Section	I. Description and General Discussion		
	General .....	7.1.1	47
	Types .....	7.1.2	47
	Fire resistance ratings .....	7.1.3	48
	II. Roof Decks for Asbestos-Cement Roofs		
	Asbestos-cement shingles .....	7.2.1	48
	Corrugated asbestos-cement sheets .....	7.2.2	48
	III. Storage and Handling of Asbestos-Cement Roofing		
	Asbestos-cement shingles .....	7.3.1	48
	Corrugated asbestos-cement sheets .....	7.3.2	48
	IV. Determining Treatment for Asbestos-Cement Roofs .....	-----	48
	V. Maintenance and Repair Methods-Asbestos-Cement Roofing		
	Asbestos-cement shingles .....	7.5.1	49
	Asbestos-cement corrugated sheets .....	7.5.2	49
	VI. Reroofing with Asbestos-Cement Roofing		
	Asbestos-cement shingles .....	7.6.1	49
	Asbestos-cement corrugated sheets .....	7.6.2	50
CHAPTER	8. SLATE ROOFING		
Section	I. Description and General Discussion		
	Description .....	8.1.1	51
	Availability .....	8.1.2	51
	Characteristics .....	8.1.3	51
	Fire classification .....	8.1.4	51
	II. Roof Decks for Slate Roofs .....	-----	51

		Paragraph	Page
CHAPTER	8. (Continued)		
Section	III. Storage and Handling of Slates .....	-----	52
	IV. Determining Treatment of Slate Roofs		
	General .....	8.4.1	52
	Replacement or Re-Use .....	8.4.2	52
	V. Maintenance and Repair Methods-Slate Roofs		
	General .....	8.5.1	52
	Replacing broken slate .....	8.5.2	52
	VI. Reroofing with slate		
	Preparing deck for reroofing .....	8.6.1	58
	Applying slate roof .....	8.6.2	53
CHAPTER	9. TILE ROOFING		
Section	I. Description and General Discussion		
	General .....	9.1.1	54
	Sloping roofs .....	9.1.2	54
	Promenade tile .....	9.1.3	54
	Weights .....	9.1.4	54
	Fire classification .....	9.1.5	54
	II. Decks for Tile Roofs		
	Sloping decks .....	9.2.1	54
	Flat decks .....	9.2.2	54
	III. Storage and Handling of Tiles .....	-----	54
	IV. Determining Treatment for Tile Roofs		
	Sloping roofs .....	9.4.1	55
	Flat roofs with promenade tiles .....	9.4.2	55
	V. Maintenance and Repair Methods-Tile Roofs		
	Sloping roofs .....	9.5.1	56
	Promenade tile on flat decks .....	9.5.2	56
	VI. Reroofing Sloping Roofs with Tile		
	Preparing deck .....	9.6.1	56
	Applying tile roof .....	9.6.2	56
CHAPTER	10. WOOD-SHINGLE ROOFING		
Section	I. Description and General Discussion		
	General .....	10.1.1	57
	Description .....	10.1.2	57
	Preservative treatment .....	10.1.3	57
	Specification .....	10.1.4	57
	II. Roof Decks for Wood-Shingle Roofs .....	-----	57
	III. Storage and Handling of Wood Shingles .....	-----	58
	IV. Determining Treatment for Wood-Shingle Roofs .....	-----	58
	V. Maintenance and Repair Methods-Wood Shingle Roofs		
	Warped shingles .....	10.5.1	58
	Removing cracked or rotted shingles and applying new ones .....	10.5.2	58
	Treating shingles with creosote or shingle stain .....	10.5.3	58
	VI. Reroofing with Wood Shingles		
	General .....	10.6.1	59
	Preparing deck for reroofing with wood shingles .....	10.6.2	59
CHAPTER	11. METAL ROOFING		
Section	I. Description and General Discussion		
	General .....	11.1.1	60
	Expansion and contraction .....	11.1.2	60
	Galvanic action .....	11.1.3	60
	Workability .....	11.1.4	61
	Types of metal roofing .....	11.1.5	61
	Fire protection .....	11.1.6	63
	Soldering .....	11.1.7	63
	Thickness of sheet metals .....	11.1.8	68
	II. Roof Decks for Metal Roofings .....	-----	68
	III. Storage and Handling of Metal Roofings .....	-----	68

		Paragraph	Page
CHAPTER	11. (Continued)		
Section	IV. Treatment for Metal Roofs		
	Copper roofing .....	11.4.1	69
	Terne roofing .....	11.4.2	70
	Galvanized steel roofing .....	11.4.3	71
	Aluminum roofing .....	11.4.4	72
	Corrosion-resisting (stainless) steel .....	11.4.5	72
	Protected metal roofing .....	11.4.6	73
CHAPTER	12. FLASHINGS AND APPURTENANCES		
Section	I. Wall,, Chimney, and Monitor Flashing		
	General discussion .....	12.1.1	76
	Flashing failures .....	12.1.2	76
	Maintenance and repair methods .....	12.1.3	78
	Reroofing .....	12.1.4	80
	II. Vent Flashings (Ventilators, Plumbing Stacks, etc.)		
	General discussion .....	12.2.1	80
	Failures-vent flashings .....	12.2.2	80
	Maintenance of vent flashings .....	12.2.3	81
	Repair of metal vents during reroofing .....	12.2.4	81
	III. Valley Flashings		
	General discussion .....	12.3.1	82
	Failure of valley flashings .....	12.3.2	82
	Maintenance and repair .....	12.3.3	82
	IV. Drainage Systems		
	General discussion .....	12.4.1	83
	Inspection .....	12.4.2	84
	Maintenance and repair .....	12.4.3	85
	V. Gravel Stops and Metal Edging		
	General discussion .....	12.5.1	86
	Inspection .....	12.5.2	86
	Maintenance and repair .....	12.5.3	86
	VI. Other Projections		
	General discussion .....	12.6.1	88
	Maintenance and repair .....	12.6.2	88
	Reroofing .....	12.6.3	88
CHAPTER	13. SPECIAL ROOFINGS		
Section	I. Elastomeric Roofing		
	Description and general discussion .....	13.1.1	89
	Use of elastomeric roofing .....	13.1.2	89
	II. Bare Concrete Roofs-Tropical Areas .....	-----	89
	III. Roofing in Arctic Areas		
	General .....	13.3.1	89
	Vapor barrier .....	13.3.2	90
	Roof slope .....	13.3.3	90
	Sheet metal eaves flashing (strip shingles) .....	13.3.4	90
	Provision for expansion and contraction .....	13.3.5	90
CHAPTER	14. SAFETY		
Section	I. General		
	Introductory .....	14.1.1	91
	Storage and handling of materials .....	14.1.2	91
	Ladders .....	14.1.3	91
	Scaffolds .....	14.1.4	91
	Roof brackets .....	14.1.5	92
	II Heating and Handling Bituminous Materials		
	General .....	14.2.1	92
	Precautions .....	14.2.2	92
	III. Sheet Metal Working		
	Tools and equipment .....	14.3.1	92
	Precautions .....	14.3.2	92
	IV. Fire Prevention and Other Shop Precautions		
	General .....	14.4.1	94
	Precautions .....	14.4.2	94



	Page
APPENDIX A. Department of Defense Instructions .....	95
B. Technical Manuals .....	96
C. Material Specifications and Standards .....	97
D. National Bureau of Standards Publications .....	100
E. Industry Publications .....	101
F. Guide Specifications for Military Construction .....	102
G. Sample Historical Record Formats and Inspection Formats .....	103
INDEX .....	109

## ILLUSTRATIONS

Figure	Page
1 Bitumen flowing between open joints .....	7
2 Alligatoring caused by heavy application of asphalt on smooth-surfaced built-up roof .....	7
3 Wrinkles, buckles, lack of adhesion of felts .....	8
4 Asphalt shingles nailed too high .....	9
5 Inadequate provision for drip at eave-note damage to roof deck .....	10
6 Action of wind on shingles nailed too high-can be eliminated by proper nailing and using wind-resistant shingles .....	12
7 Defective flashings are frequently responsible for leaks attributed to failure of membrane .....	13
8 Results of poor workmanship in applying built-up roof .....	15
9 Laying felts mechanically and brooming-in after felt is rolled into hot bitumen .....	16
10 Surface coating of hot bitumen should be poured, not mopped .....	19
11 Insufficient bitumen to embed aggregate surfacing .....	20
12 Bituminous coating exposed due to loss of aggregate .....	22
13 Hot bitumen poured on unprepared surface-note lack of adhesion .....	23
14 Felts exposed and weathered due to loss of aggregate and bituminous coating .....	23
15 Small blisters or buckles-when bare should be treated as bare areas (para 4.5.2.1) .....	24
16 Severe alligatoring on thick coating of asphalt .....	24
17 Alligatoring and cracking of a cold coating over alligatored asphalt surface after 1 year exposure .....	25
18 Coating weathered off small areas-felt exposed and partially disintegrated .....	26
19 Large blister on smooth-surfaced roof .....	26
20 Felts disintegrated and disbonded-reroofing is mandatory .....	27
21 Test cut in gypsum deck-crack extends up through roofing membrane mopped directly to deck .....	28
22 Wind-resistant asphalt strip shingles with factory applied spots of adhesive .....	32
23 Loss of mineral surfacing granules due to normal weathering .....	34
24 Difference in weathering of asphalt shingles on southern and eastern exposures .....	34
25 Severe loss of mineral granules and coating asphalt due to weathering .....	35
26 Clawed asphalt strip shingles .....	35
27 Recoated asphalt shingles-note damage resulting from brittleness .....	36
28 Proper method of nailing asphalt shingles .....	37
29 Location of cement under tabs .....	37
30 Hail damage showing broken shingles-reroofing mandatory .....	38
31 Hail damage showing shingles unbroken .....	38
32 Exposed nail application of roll roofing parallel to the eaves .....	41
33 Application of roll roofing by concealed nail method parallel to the eaves .....	42
34 Application of double coverage (wide selvage) roll roofing parallel to the eaves .....	42
35 Repairing asphalt roll roofing .....	44
36 Closeup view-repaired roll roofing seam .....	45
37 Method of inserting new slate .....	53
38 Replaced tiles fastened in place with metal strips .....	55
39 Movement of expansion joints .....	61
40 Development of standing and batten seams .....	62
41 Batten seam roofing .....	63
42 Standing seam roofing .....	64
43 Development of lock seams .....	65
(1) Single lock seam .....	65
(2) Double lock seam .....	65
(3) Development of double lock seam with cleats .....	65
44 Typical details of cleats .....	65
45 Flat seam roofing .....	66
46 Corrugated roofing .....	67
47 Typical details of chimney flashings .....	77
48 Puncture resulting from lack of cant strip .....	78
49 Open laps and split in base flashing .....	79
50 Improper installation of vent and stack flashings .....	81
51 Debris on roof impedes drainage .....	88
52 Drain not located in low area-ponding sometimes caused by structural defect .....	84
53 Clogged drains-drains must be kept clean to function properly .....	84
54 Accumulation of gravel causing collapse of gutter .....	85
55 Deteriorated gravel stop .....	87
56 Precautions that reduce accidents .....	93

## TABLES

Table	Page
1. Recommended minimum roof slopes for various roofings .....	11
2. Expansion and contraction .....	60
3. Sheet metal gages .....	68
4. Properties of sheet metal .....	74
5. Use and recommended thickness of sheet metal .....	75

# CHAPTER 1

## INTRODUCTION

---

### Section I. GENERAL

#### 1.1.1 Purpose

The purpose of this manual is to provide guidance to personnel engaged in or responsible for the inspection, maintenance, repair, or replacement of roofing at military installations.

#### 1.1.2 Scope

This manual contains information applying to safety measures and inspection, maintenance, repairs, reroofing, and causes of failures of built-up roofing, asphalt-shingle roofing, roll roofing, asbestos-cement roofing, metal roofing, slate roofing, tile roofing, wood-shingle roofing, and flashing appurtenances. For convenience, each type of roofing is treated in a separate chapter, except for cross reference to avoid repetition. Information on sheet metal is presented to the extent that it pertains to roofing.

#### 1.1.3 References

Other publications contain detailed information on maintenance of numerous component parts of roofing. References to them are made wherever applicable. Such publications and applicable specifications are listed in the appendixes A through E. References to Federal, Military or American Society for Testing and Materials (ASTM) specifications are to the current issues of these specifications as identified by their basic numbers.

#### 1.1.4 Painting

Where painting is not covered in this manual, reference should be made to the tn-services manual entitled "Paints and Protective Coatings," (AFM 85-3, TM 5-618, NAVFAC MO-110).

#### 1.1.5 Fire Classification of Roof Coverings for Military Construction

Roof coverings for military construction should have at least a "Class C" classification for external fire exposure as listed by the Underwriters' Laboratories, Inc., Factory Mutual Engineering Division, or other recognized testing laboratory. In addition, it is essential that roofing systems over steel and wood decks be in accordance with roof

deck constructions as listed by Underwriters' Laboratories, Inc. or Factory Mutual Engineering Division for spread of fire beneath the deck.

#### 1.1.6 Manufacturers' Instructions

Information is presented in this publication in general terms, since it is impossible to cover in detail the many varied types of roofing materials and their component accessories produced by numerous manufacturers. Minute detail is omitted here because of readily available excellent instructions, diagrams, drawings, and photographs that most manufacturers provide with their roofing products.

#### 1.1.7 Use of Accepted Materials

Materials to be incorporated in roofing work should comply with the latest issue of Federal, Military, or ASTM specifications, or with instructions issued by the military department concerned. Use of proprietary materials should be avoided and materials that do not comply with an appropriate Federal, Military, or ASTM specification should not be used. The manufacturer's printed label on material should show applicable specifications.

#### 1.1.8 Structural Problems

Structural problems must be resolved by qualified engineers. Adequacy of existing structural systems to carry anticipated loads must be verified.

#### 1.1.9 Method of Accomplishing Work

Roofing maintenance and repairs should be accomplished by qualified personnel only. Minor maintenance and repair work, the scope of which is difficult to determine, or emergency work required to provide immediate protection against interior water damage, or work that involves a threat to a secure area, is best accomplished by installation personnel. Major repair or complicated reroofing projects should be accomplished by contract methods. The installation engineer does not usually have the necessary staffing or equipment to attempt work of large scope. Further, attempting work of large scope generally results in the neglect of

essential routine maintenance. Every attempt should be made to schedule major repair and reroofing projects for accomplishment in dry weather during ambient temperatures of at least 40° F.

### **1.1.10 Access to Roofs**

Traffic on roofs inevitably results in damage to the roofing. Traffic on roofs should therefore be kept to a minimum and access limited. Where traffic on roofs cannot be avoided, walkways must be provided.

*1.1.10.1 Access Doors.* All doors leading directly to roofs should be padlocked, with locks keyed alike. A sign should be stenciled on the inside of each door indicating that roofs are off-limits. Necessary equipment for forced exit in case of fire should be provided as required.

*1.1.10.2 Access Ladders.* A sign should be stenciled on the side of the building adjacent to each fixed ladder leading to roofs, stating that roofs are off-limits.

### **1.1.11 Equipment on Roofs**

Equipment should not be placed on roofs except as absolutely necessary. Unauthorized equipment such as radio or television aerials should be removed.

### **1.1.12 Use of Construction Guide Specifications**

It is often feasible to utilize military or federal (FCGS) construction guide specifications for re-roofing work. However, it is essential in all such cases to carefully adapt the guide specification to suit the project under consideration. In particular, the work to be accomplished should be clearly delineated including that pertaining to retention or removal of existing materials, and portions of the guide specification should be modified or deleted as appropriate.

### **1.1.13 Roofing Colors**

Roof surfaces of high reflectivity should be employed where it is desirable to reduce solar heat penetration and facilitate cooling. Where asphalt shingle or roll roofing is applied to military buildings, other than family housing, colors should be limited to white, off-white, gray, or green. Family housing is restricted to white or light gray. On aggregate-surfaced built-up roofing, crushed marble or other light colored aggregate is used to give a heat-reflective surface. For smooth-surfaced built-up roofing, aluminum pigmented asphalt coatings are employed to provide a reflective weathering surface.

## **Section II. ARMY RESPONSIBILITY**

### **1.2.1 General**

AR 420-10 pertains to facilities engineering, assigns responsibility, and delegates approval authority for real property facilities projects.

### **1.2.2 Criteria, Standards, and Procedures**

AR 420-70 prescribes criteria, standards, and procedures in connection with facilities engineer responsibilities for buildings, structures, and training facilities.

## **Section III. NAVY RESPONSIBILITY**

### **1.3.1 Naval Facilities Engineering Command**

The overall responsibility for the maintenance of the Department of the Navy shore installations is assigned to the Commander, Naval Facilities Engineering Command (NAVFAC). His authority is delegated to the Commanders and Commanding Officers of NAVFAC's Engineering Field Divisions (EFDs) who provide overall technical guidance in operations and maintenance matters to these shore installations.

### **1.3.2 Commanding Officer**

The Commanding Officer at each Department of the Navy shore installation is responsible for providing an adequate maintenance program.

Normally, these responsibilities are delegated to the Public Works Centers or Public Works Departments/Maintenance Departments, as appropriate.

### **1.3.3 Public Works Center/Public Works Department/ Maintenance Department**

At each Naval and Marine Corps installation, the Commanding Officer of a Public Works Center, or the Public Works Officer/Maintenance Officer is responsible to the Commanding Officer for the provision of—

- (1) Inspections and surveys to determine and identify roofing conditions.
- (2) Recommendations for maintenance

standards and procedures that affect the life of the roofs.

(3) Establishing Dynamic Equipment Inspection/Service (preventive maintenance) Programs.

(4) Trained and qualified personnel to accomplish effective roof maintenance.

(5) Periodic supervisory personnel training, education, and certification in maintenance programs that utilize work improvement main-

tenance techniques.

(6) Inspections and instructions to assure that labor, materials and equipment are used properly and safely in accordance with pertinent regulations, and that operations are planned and supervised by qualified personnel.

(7) Coordination with civilian and other governmental agencies that have similar maintenance capabilities.

## **Section IV. AIR FORCE RESPONSIBILITY**

### **1.4.1 Directives**

The responsibility within the Air Force for the Operations and Maintenance of Real Property is defined in the following publications:

(1) AFR 85-5, "Operation and Maintenance of Real Property," delegates the responsibilities for the maintenance and protection of Real Property.

(2) AFR 85-6, "Real Property, Maintenance, Repair and Construction," controls the classification and level of approval authority for all work.

(3) AFM 85-1, "Resources and Work Force Management," sets the work processing control procedure for all work.

(4) AFM 88-15, "Air Force Design Manual — Criteria and Standards of Air Force Construction," controls the selection of materials for all work.

### **1.4.2 Headquarters, USAF Level**

Within HQ USAF, the Director of Civil Engineering is responsible for developing policy and procedures and for administering and supervising an effective operations and maintenance program for all real property under the control of the Air Force.

### **1.4.3 Major Command Level**

The commander of each major command is responsible for establishing and accomplishing an effective O&M program at all installations under his command.

### **1.4.4 Base Commander Level**

The base commander will plan, initiate, and supervise through his Base Civil Engineer the execution of the engineering responsibilities for the operations and maintenance of real property under his jurisdiction.

## CHAPTER 2

### GENERAL DISCUSSION

---

#### 2.1.1 Importance of Periodic Inspections

The first step in the establishment of a proper roof maintenance program is the adoption of a periodic inspection system. The early discovery and correction of minor defects forestalls major repairs and materially extends the date when reroofing is necessary. Since a large proportion of early roof failures are flashing failures, the regular inspection of flashings is of vital importance. Regular inspections should be made by competent personnel at least once each year, and always in the spring. This time is best because it follows the severe winter conditions and is followed by the period best suited for roofing work. Inspections should be made even though a roof has been exposed for less than one year. The first yearly inspection is of great importance because it frequently discloses minor defects that were not apparent when the roofing or reroofing job was completed. Roof inspection records should be maintained and made a part of the historical records for each structure. The records should contain a survey and classification of all roof areas with entries indicating age and condition. These continuing records will be of considerable value in determining the roof treatment that may be necessary and in preparing an efficient scheduled roof maintenance program. Suggested forms for maintaining historical records and for use in inspections of built-up roofing and asphalt shingle roofing are shown in the appendix. Similar forms may be prepared for the other types of roofing.

#### 2.1.2 Importance of Special Inspections

In addition to scheduled yearly inspections, on-the-roof inspections must be made —

(1) After exposure of the roofs to unusually severe weather conditions such as very strong winds, hail or long-continued rain.

(2) Immediately prior to preparation of projects for maintenance, repair, or reroofing. The individual(s) responsible for preparation of project documents and for contract supervision should personally get up on the roof to make this inspection and not rely on information received

second hand from others. The condition of the membrane, insulation, and decking must be determined for built-up roofing. This will usually require the removal of samples of the roofing assembly for analysis and inspection. Convenient sizes are 4 inches wide by 36 inches long or 12 inches square extending down to the roof deck. The number and size of samples will be determined by the types of roofing being worked on and the need for information about the roof plies. The holes created by sample removal should be patched as soon as possible. The inspection should include an examination of the roof deck from the underside for evidence of leaks, deteriorated decking, structural cracks or movement, and other defects. Walls and parapets should be examined for cracking, deterioration, loose coping efflorescence, and evidence of entrance of water.

(3) To ascertain or verify the backlog of essential maintenance and repair.

#### 2.1.3 Importance of Contract Inspection

The importance of competent inspection during initial roof construction or during reroofing to insure good workmanship and compliance with project specifications cannot be overemphasized. Most early roofing problems or failures are attributable to poor workmanship and failure to follow specifications. Inspection on government projects is particularly important since essentially all contracts are awarded on the basis of a low bid. The project design engineer or the facilities engineer most familiar with the type of roofing involved should be assigned the primary responsibility for ensuring that the roof system is installed in strict accordance with the specifications. Inspectors assigned to a roofing project should work under the guidance of the project design engineer. The project engineer should make sure that the inspector has become fully familiar with and understands the requirements of the contract. The inspector should maintain a log book containing pertinent entries concerning the project.

### **2.1.4 Maintenance**

Maintenance is the recurrent, day to day, periodic, and scheduled work required to preserve and restore a facility to a useful condition. Roof maintenance is defined herein as the treatment given a roof prior to any actual failure. It may consist in the correction of minor defects in small areas, such as resurfacing bare spots in aggregate-surfaced built-up roofing; or it may involve treatment of the entire roof area, such as recoating smooth-surfaced built-up roofing. The importance of proper roof maintenance cannot be emphasized too strongly. With good maintenance, the useful life of the roof is extended many years and the cost per year for roofing is reduced. Some types of roofing require more maintenance than others, but every establishment should have a well trained roof maintenance crew of a size determined by the kinds of roofing and the roof areas involved. Further, the crew should be properly equipped to make required repairs. The equipment should include a bitumen kettle. Other equipment such as mechanical scrapers might be warranted if the volume of work is great.

### **2.1.5 Repairs**

Repair is the restoration of a facility by overhaul, reprocessing, replacement of constituent parts or materials, and which cannot be corrected through maintenance as defined in paragraph 2.1.4. Roof repair, as distinguished from roof maintenance, is defined herein as the treatment given a roof following at least partial failure. Such repair may be minor involving small areas, such as the replacement of broken slate or tile, or it may be major involving the whole roof, such as the application of additional layers of felt over built-up roofing.

### **2.1.6 Reroofing**

Every roof ultimately requires reroofing. While the main purpose of this manual is to serve as a guide for extending the useful life of roofs by proper maintenance and repair methods, of equal importance is the development of guide lines for determining the point at which maintenance and repair treatments become unsound economically and reroofing is required. Many factors enter into this determination. The more important are: age of roofing, unusual exposure conditions such as hail or strong winds, previous maintenance and repair or lack of these, and the current and possible future use of the structure. It is only by weighing all of the pertinent factors that a proper decision can be made. Reroofing is generally a replacement in kind. However, it is essential that reroofing include corrective action to remedy design or construction deficiencies if they exist. Also, advantage should be taken of improved materials, methods, and techniques.

### **2.1.7 Research on Roofing**

Roofing systems and their components are continually being investigated under Government-sponsored research programs. Recent investigations into the performance of roofing have been sponsored jointly by the Army, Navy, and Air Force at the Building Research Division of the National Bureau of Standards. The investigations cover various roofing materials and systems as well as methods of application. Since much recent military construction has involved relatively flat roof decks, a considerable part of the research effort has been spent on the performance of built-up roof systems. A list of pertinent National Bureau of Standard's reports is contained in appendix D.

## CHAPTER 3

### CAUSES OF ROOF FAILURES

---

#### 3.1.1 Lack of Maintenance

The failure to find and correct minor defects and deterioration in its earliest stages is probably the greatest cause of premature roof failures. This is particularly true of built-up roofing applied on relatively low sloped roofs.

#### 3.1.2 Weathering

All roofing materials deteriorate on exposure to the weather, the rate of deterioration being determined largely by the kind of material and the conditions of exposure. Some slate roofs in this country are more than 100 years old; the oldest copper roof is more than 200 years old, and "tin" roofs exposed 80 or more years are not uncommon. On the other hand, roofs of poor quality slate have been known to fail in 10 years; copper roofs may fail within 1 year through failure to provide for expansion and contraction, though the metal has not deteriorated; and "tin" roofs deteriorate rapidly when painting is neglected. These are only a few of the examples that might be given. In general, inorganic roofing materials tend to deteriorate less rapidly on exposure than the organic ones. Metal roofs subject to rapid oxidation must be protected. All types of roofing may be damaged by hail. Exposure to air pollutants, and industrial or salt atmospheres may accelerate the deterioration process of some roofings.

#### 3.1.3 Use of Unseasoned Lumber or Improper Grade Plywood

The use of unseasoned lumber for roof framing and roof decks with subsequent shrinkage and warping was a frequent cause of premature roof failure on World War II, wood, mobilization type construction. Movement in the roof deck may cause breakage of rigid roofing materials such as slate, tile, and asbestos-cement shingles, and unsightly buckles in roll roofings, asphalt shingles, and built-up roofs. The use of interior type plywood for roof decking with subsequent delamination due to dampness or wetting can result in premature roof failure. The roofing membrane can be damaged by the warping of the ends of random length. tongue and groove, wood decking

where the end joints do not fall over the supporting joists.

#### 3.1.4 Improper Storage

Roofing materials, though intended for direct exposure to the weather, may be harmed if exposed before application. Consequently, they should be stored under cover at all times. Improper storage often results in damage to roofing materials and poor performance on the roof. The materials, particularly insulation and rolls of felt, must never be stored in direct contact with the ground or stacked too high. Manufacturers' instructions on stacking, storage, and handling should be followed.

#### 3.1.5 Improper Application of Roofing Materials

*3.1.5.1 General.* Workmanship in applying roofing materials is as important as the selection of the proper materials. Inferior materials applied well will give adequate service as long as the materials resist weathering, but the best roofing materials improperly applied will give poor service from the beginning and result in premature failure.

*3.1.5.2 Built-Up Roofs.* Some common application faults are:

- (1) Failure to take precautions over decks with open joints which permits bitumen to drip (fig. 1).
- (2) Failure to provide a felt or metal bitumen stop at eaves and rakes resulting in bitumen dripping down the exterior wall surface, and exposing the unprotected ends of the felt.
- (3) Entrapping moisture in roof insulation, resulting in blisters and other failures. A blister is illustrated in figure 19.
- (4) Applying built-up roofs in weather which is too cold or wet.
- (5) Inadequate adhesion of felts in built-up roofs, resulting in the blowing-off or the slipping of felts on steep slopes. Also inadequate fastening of felts to deck.
- (6) Improper moppings of hot bitumen (too much or too little) between the plies of felt.
- (7) Inadequate application (mopping instead of pouring) of hot bitumen in the application of



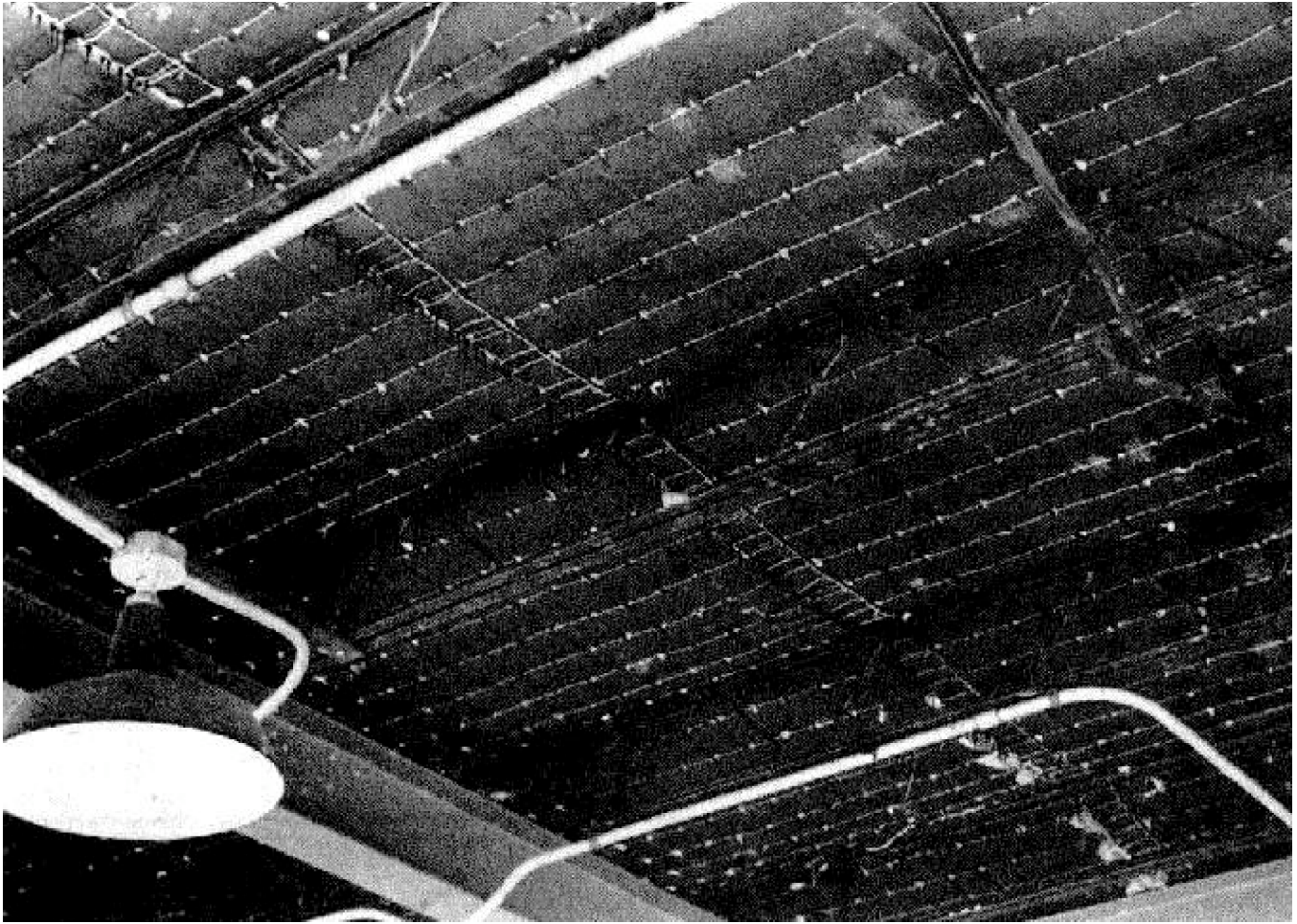

*Figure 1. Bitumen flowing between open joints.*

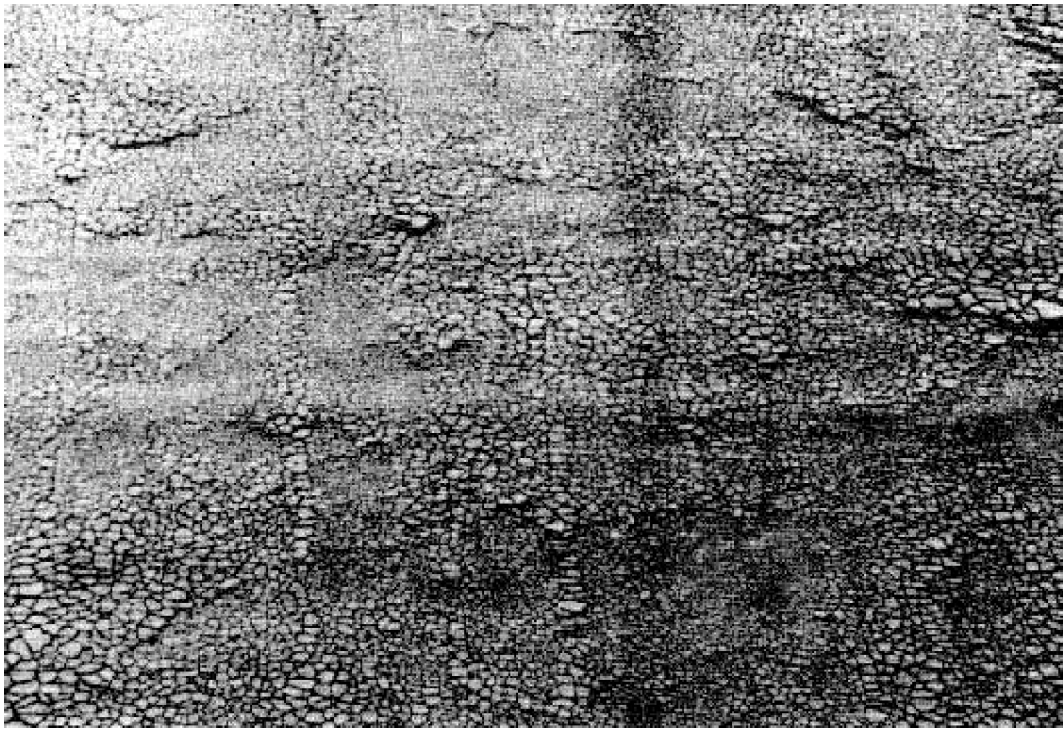

*Figure 2. Alligatoring caused by heavy application of asphalt on smooth-surfaced built-up roof.*



Figure 3. Wrinkles, buckles, lack of adhesion of felts.

flood coat for slag or gravel surfaced roofs. Pouring of bitumen is shown in figure 10.

(8) Improper application temperature of asphalt or tar bonding coats (too cold may result in lack of adhesion or use of too much bitumen; too hot may result in not enough bitumen between plies).

(9) Too heavy application of asphalt on the weather surface of smooth surfaced built-up roofs resulting in alligating of coating (fig. 2).

(10) Failure to broom felts smoothly behind the mop, resulting in poor adhesion, wrinkles and buckles (fig. 3).

(11) Improper preparation of surfaces to be bonded, particularly in patching slag or gravel surfaced roofs.

(12) Failure to embed metal gravel stops or metal expansion joints in roofing cement; failure to adequately nail gravel stops.

(13) Placing drains too high resulting in ponded water.

(14) Failure to provide smooth flat fit of roofing felt against cant strips, parapet walls and similar areas of flashing, causing air pockets and nonsupport of felts, resulting in holes being kicked in the roofing in these areas.

*3.1.5.3 Asphalt Roll Roofing.* Some common application faults are—

(1) Failure to cement the seams of roll roofing or to use the proper kind of cement.

(2) Applying roll roofings with exposed nails.

(3) Nailing roll roofing too close to the edge of the sheet.

(4) Failure to cut roll roofing into short (12 to 18 foot) lengths and failure to permit it to lie flat to lose the "roll."

(5) Failure to cover resinous knots, knot-holes, or wide cracks in the roof deck with sheet metal.

(6) Failure to use metal drip edge at eaves and rake.

*3.1.5.4 Asphalt Shingle Roofing.* Some common application faults are—

(1) Nailing asphalt shingles too high (fig. 4).

(2) Failure to use wind resistant asphalt shingles having factory applied adhesive or to cement down tabs of asphalt shingles with quick-drying cement in windy areas or where slope is less than 4 inches per foot.



Figure 4. Asphalt shingles nailed too high.

(3) Failure to provide for proper drip at eaves or rake either by overhanging shingles sufficiently or by using a metal drip edge (fig. 5).

(4) Failure to provide roll roofing or double felt underlay over eaves wherever there is a possibility of an ice dam forming along the eaves and causing a backup of water; failure to provide a sheet metal eaves flashing in locations where there is a possibility of glaciation and ice damage at the eaves.

(5) Failure to use double felt underlayment on roofs having slope of less than 4 inches per foot.

**3.1.5.5 Metal Roofs.** Some common application faults are—

(1) Failure to provide adequate side and end laps with corrugated sheet roofings.

(2) Failure to use mastic sealing compound at end and side laps.

(3) Failure to use asphalt or rubber filler strips where required.

(4) Failure to paint tin (terne) roofing.

(5) Failure to provide adequately for expansion and contraction with changes in temperature.

(6) Failure to fasten sheets adequately.

(7) Locating exposed fasteners in valleys instead of ridges for standard corrugated sheets.

**3.1.5.6 Rigid Roofing Materials (Slate, Asbestos-Cement, Tile).**

(1) Nailing too tightly.

(2) Using improper nails.

### 3.1.6 Use of Improper Materials

Practically all roofing materials are best suited for a particular type of service and some are definitely unsuited to certain conditions. It is obvious that shingle-type materials serve best on the steeper slopes and that the lower pitched roofs require roofing that will provide a continuous sheet over the entire area. Generally, shingle-type roofing (asphalt, asbestos-cement, slate, wood) may be used safely on slopes of five inches or more per foot. Shingle-type roofing may be used on lower slopes if proper precautions are taken.

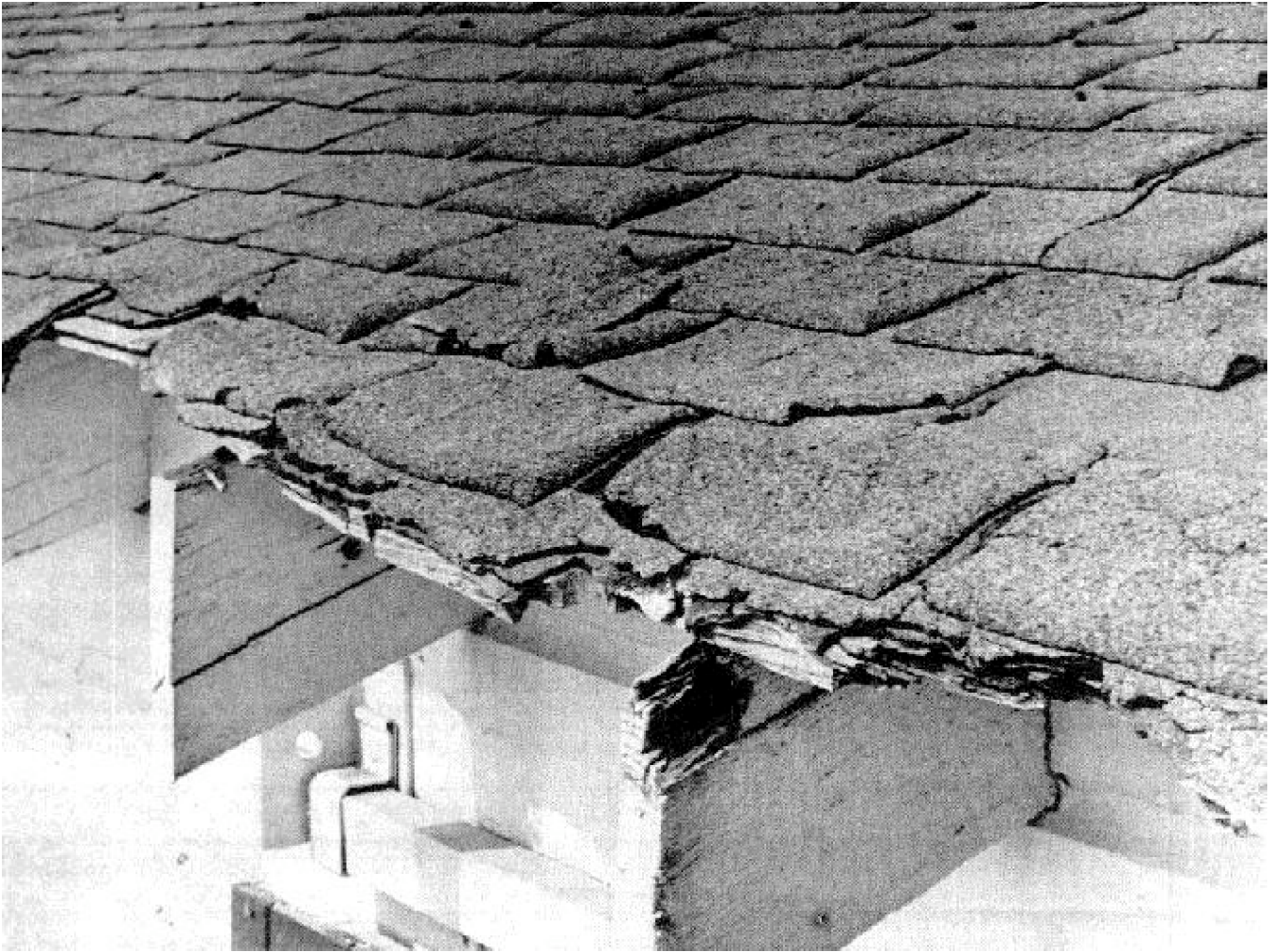

*Figure 5. Inadequate provision for drip at eave — note damage to roof deck.*

Recommended minimum roof slopes for various roofings are listed in table 1. Asphalt roll roofings, including wide-selvage roofing, may be used on slopes of two inches or more per foot. Wide-selvage roofing may be used on slopes of 1 inch or more per foot; however, it will not resist weathering as well because of poor roof drainage. Built-up roofs are best suited to roof decks that range from  $\frac{1}{2}$  inch to 2 inches per foot, though they may be used on slopes from dead-level to 3 inches per foot. Metal roofing in sheet form and corrugated asbestos-cement roofing are not generally used on slopes lower than 3 inches per

foot. These include special shapes of galvanized and aluminum sheets, protected metal sheets and all batten and standing seam metal roofings. Corrugated or V-beam metal roofing may be used on lower slopes if the depth of corrugations is increased or if the sheets extend in one piece from eave to ridge. Soldered seam metal roofs (Copper, terne) may be used on flat or nearly flat decks. Information regarding the slope on which it is intended that various roofing materials be used may often be found in the applicable Federal, Military or ASTM specifications.

Table 1. Recommended Minimum Roof Slopes for Various Roofings

Type of roofing	Recommended minimum slope	Remarks
Built-up, coal-tar.....	1/2 inch per foot.....	May be applied on existing roofs having slopes less than 1/2 inch per foot. 2 inches per foot slope maximum.
Built-up, asphalt.....	1/2 inch per foot.....	For Alaska, 1 inch per foot minimum slope. May be applied on existing roofs having slope less than 1/2 inch per foot, providing low-slope type asphalt is used. Types of asphalt (softening point) suitable for use on various slopes are specified in ASTM D312. Three inches per foot maximum.
Asphalt roll roofing (application parallel to eave):		
a. Wide selvage.....	2 inches per foot.....	1 inch per foot slope for emergency construction.
b. Concealed nailing.....	3 inches per foot.....	Lap should be 3 inch. Slope of 2 inch per foot for emergency construction.
c. Exposed nailing.....	4 inches per foot.....	For 2 inch lap. Use exposed nailing method on emergency construction only.
Asphalt strip shingles.....	4 inches per foot.....	Over single layer of underlayment felt.
	3 inches per foot.....	For wind-resistant shingles over double layer of underlayment felt.
Asbestos-cement shingles.....	5 inches per foot.....	
Slate shingles.....	5 inches per foot.....	3 inches minimum headlap.
Tile shingles.....	4 inches per foot.....	Except promenade tile on flat decks.
Wood shingles.....	5 inches per foot.....	Depends on coverage (para 10.6.3).
Corrugated asbestos-cement.....	3 inches per foot.....	Increase end and side laps for localities subject to hurricanes, torrential or driving rains, or snow, and for roofs having slopes of from 3 to 4 inches per foot.
Metal roofings:		
a. Batten-seam.....	3 inches per foot.....	
b. Standing-seam.....	3 inches per foot.....	
c. Flat (soldered)-seam.....	1/2 inch per foot.....	Slope should be sufficient to prevent water from standing.
d. Corrugated sheets.....	3 inches per foot.....	May be used on slopes down to 2 inches per foot if depth of corrugations is increased. Increase end and side laps for localities subject to hurricanes, torrential, driving rains or snow, and for roofs having slopes less than 4 inches per foot.
e. Ribbed or V-beam sheets.....	3 inches per foot.....	

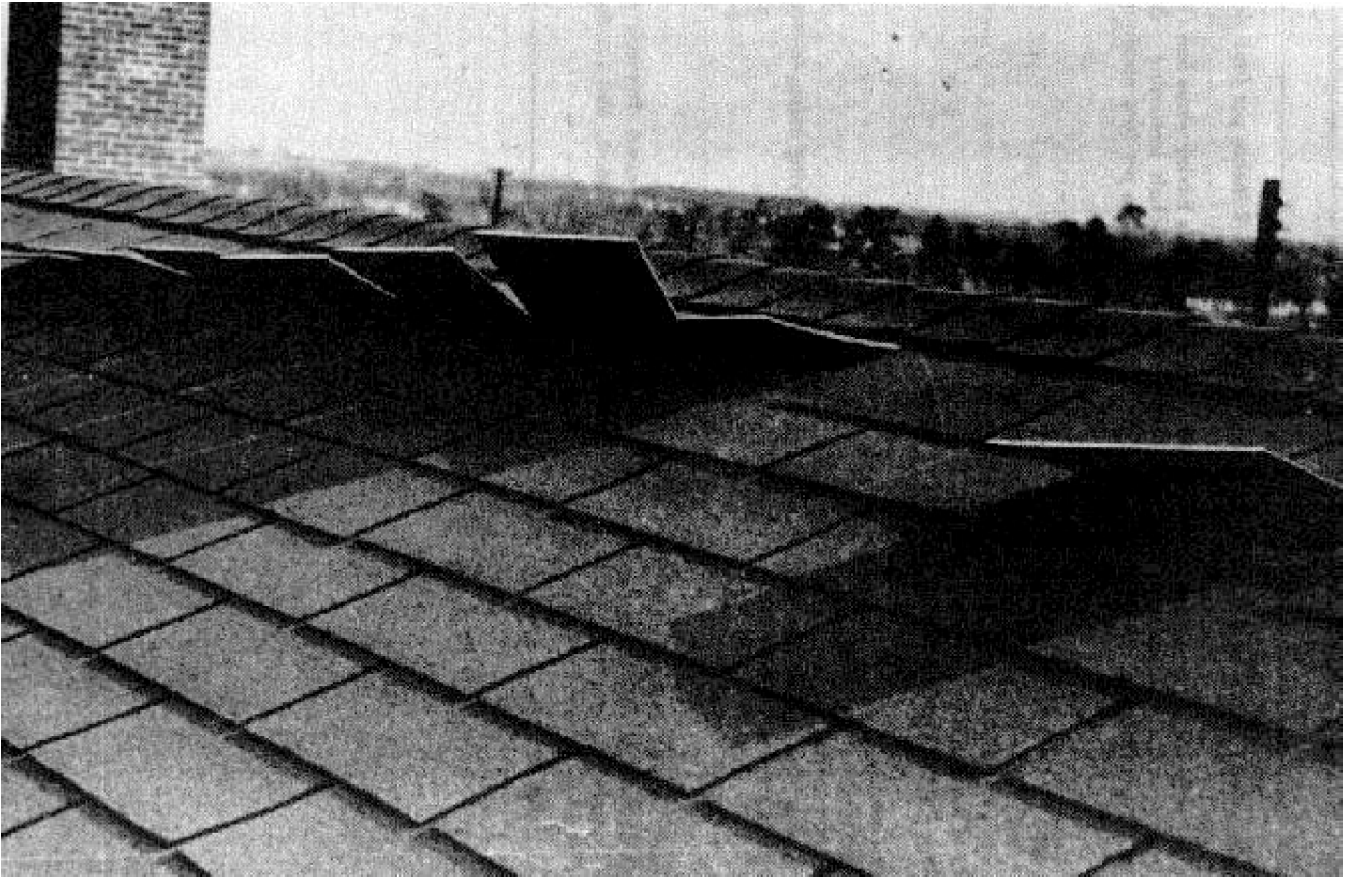

*Figure 6. Action of wind on shingles nailed too high — can be eliminated by proper nailing and using wind-resistant shingles.*

### **3.1.7. Wind Damage**

All roofings are subject to damage from strong winds and flying debris. Roofs, generally, are not designed to withstand winds of hurricane and tornado intensity. However, the greatest damage to roofs is not necessarily from hurricanes but, rather, from winds of moderate intensity and the gusts that may reach 50 to 75 miles per hour that accompany them. Asphalt roofings, particularly free-tab asphalt shingles, improperly applied are probably most susceptible to wind damage. Figure 6 illustrates the effect of a gust of wind on free-tab shingles that were nailed too high. Continued flexing of these shingles weakens them and after a number of gusts the shingle tab is blown off. The same is true if these shingles are nailed correctly, but the free tabs are not cemented down and account for the many cases where only the exposed tab of a shingle is blown loose. Free-tab asphalt strip shingles nailed correctly have been shown to resist less than 100 gusts in a simulated test. In a similar test with the tabs cemented down the shingles have resisted more than 2,000 gusts. Another cause of wind damage to roofs is the partial vacuum caused by wind blowing perpendicularly over the ridge of a roof and causing the roll roofing to tug at its

fastenings. This same effect is apparent when wind blows against the side of a building with a flat roof and is one of the important reasons for the adequate fastening of built-up roofing felts and for providing a properly fastened gravel stop. In the case of built-up roofs it is the constant pull from relatively mild winds that loosen the nails and make the roof susceptible to the first strong wind to which it is subjected.

### **3.1.8 Exposed Nails**

The tendency of exposed (uncovered) nails to work loose has probably caused most trouble with asphalt roll roofings which have been applied by the exposed nail method. However, exposed nails are always a potential source of trouble with roofings of any type. Nails used to hold down curled wood shingles invariably come loose as do nails in the battens used to deflect water away from the entrances to buildings.

### **3.1.9 Failure of Flashings**

Flashings should be designed to furnish at least as long service as the roofing. Many early roof failures are actually flashing failures. This is particularly true of built-up roofs on flat or low slope decks. Numerous cases have been observed where

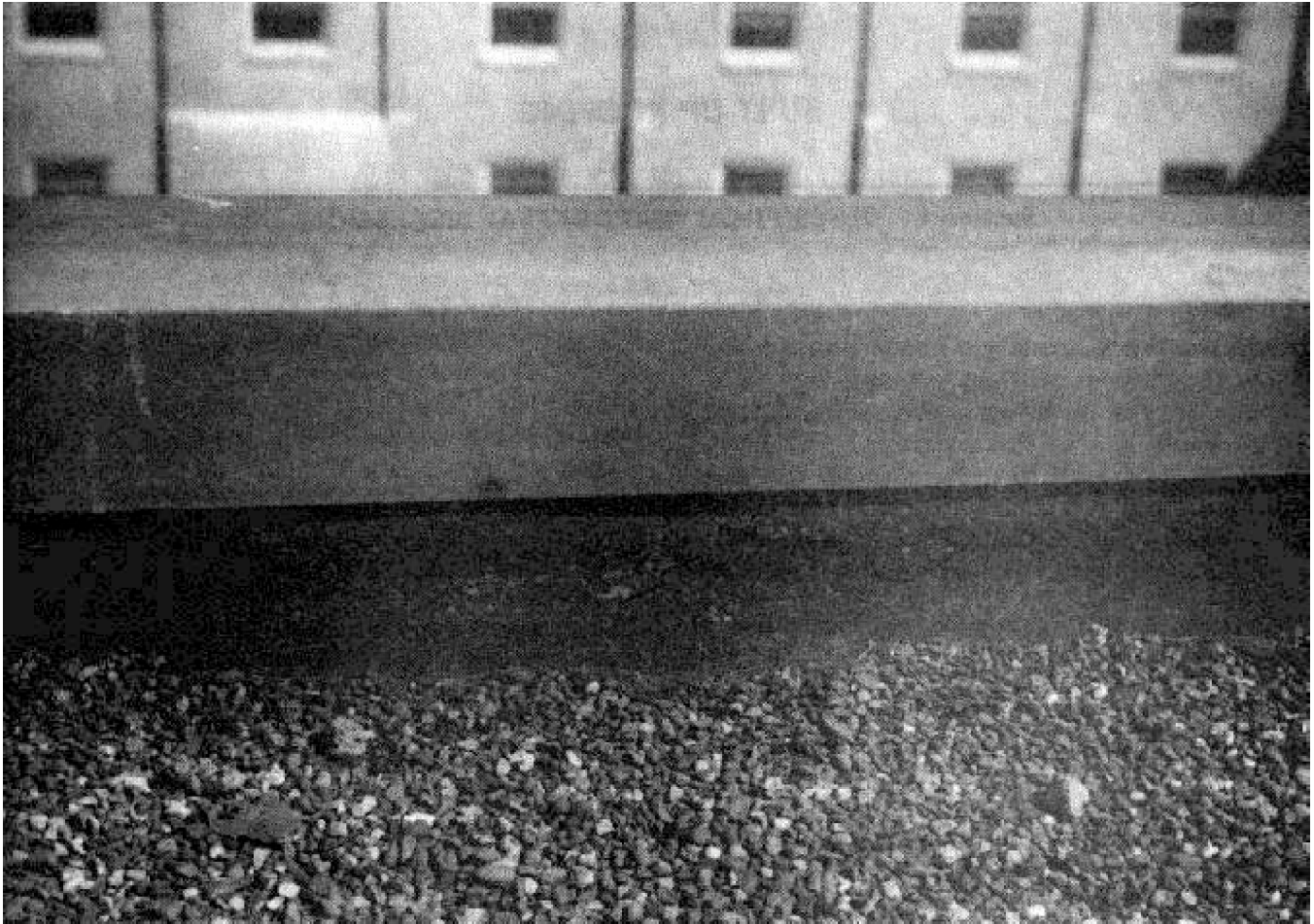

*Figure 7. Defective flashings are frequently responsible for leaks attributed to failure of membrane.*

reroofing has been requested when repair of the flashings or provision for new flashings was all that was required to make the roof leak-proof (fig. 7). When it is considered that the function of flashings is to provide a waterproof junction between the roof and other parts of the structure and between roof sections, their importance, and the importance of maintaining them properly cannot be over-emphasized. Flashings are discussed in detail in chapter 12.

### **3.1.10 Improper Design**

Troublesome and costly roofing problems are often the result of faulty initial design of the roof system. Examples are: too flexible a roof structure causing cracking of the roof membrane; inadequate roof slope and insufficient number of drains; inadequate provision for expansion and contraction; sagged roof structures; omission of walkways for traffic; mopping directly to gypsum decks; poor flashing details. Action should be taken to determine the cause of the problem and, to the extent feasible, remedy the deficiency, particularly when reroofing.

## CHAPTER 4

### BUILT-UP ROOFING

---

#### Section I. DESCRIPTION AND GENERAL DISCUSSION

##### 4.1.1 General

Built-up roofing is exactly what the name implies, a membrane built-up on the job from alternate layers of bituminous-saturated or saturated and coated felt or fabric and bitumen. Since each roof is custom-made, the importance of good workmanship cannot be overemphasized. Figure 8 illustrates extremely poor workmanship on both roof membrane and flashings.

##### 4.1.2 Slope

Built-up roofs are adapted particularly to relatively flat slopes (2 inches and less per foot) because they furnish a continuous membrane. They may be applied on slopes steeper than 2 inches per foot when proper precautions are taken. While many built-up roofs have been installed over dead level decks, the better practice is to have a minimum slope of  $\frac{1}{4}$  inch per foot or more to completely drain the roof within 48 hours.

##### 4.1.3 Bitumen

The bitumen used to saturate the felt and as a plying cement and coating for the saturated felts may be asphalt or coal-tar pitch. These can usually be distinguished by their odors. Asphalt has an oily odor and coal-tar pitch a somewhat pungent, phenolic odor. These odors can be determined best with freshly broken specimens or from the fumes of specimens that have been ignited and freshly extinguished. Asphalt can also be distinguished from coal-tar pitch if a small specimen of bitumen is placed in a glass jar filled with varsol, the jar is shaken to dissolve some of the bitumen, and the color of the resultant solution is observed. The varsol solution will turn black if the bitumen is asphalt since the asphalt being a by-product of petroleum, is soluble in varsol. The coal-tar pitch is only partially soluble in varsol. If a positive identification cannot be made by these methods, a sample should be sent to a qualified laboratory for examination.

*4.1.3.1 Coal-Tar Pitch.* Coal-tar pitch is particularly adaptable for use in the construction of the flat built-up roofs on which water collects and stands. Coal-tar pitch is more susceptible than asphalt to changes in temperature, that is, roofing grade coal-tar pitch is more fluid at high temperatures and more brittle at low temperatures than comparable roofing grade asphalts. Consequently, asphalt is better suited than coal-tar pitch for built-up roofing on slopes exceeding  $\frac{1}{2}$  inch per foot. Coal-tar pitch, because of its self-healing properties and ability to resist water, is better suited for low slopes on which water collects and stands. Coal-tar pitch conforming to ASTM Specification D-450, Type A is suitable for use with roofing. Coal-tar pitch built-up roofs are always hot-applied. The pitch is melted to a heavy liquid consistency and, except when the felts are laid mechanically (fig. 9), it is mopped when used as a plying cement and poured when used as a surface coating. Because of the susceptibility of coal-tar pitch to changes in temperature, coal-tar pitch roofs should always be surfaced with slag, gravel, crushed stone or other suitable surfacing.

*4.1.3.2 Asphalt.* Asphalt for use with built-up roofing should conform to ASTM Specification D-312, type as appropriate for the slope of roof on which the asphalt is to be applied and climatic (temperature) conditions. Generally, asphalt built-up roofs are not recommended on roof slopes over 3 inches per foot. Asphalt built-up roofs may be either hot-or-cold applied and may be either surfaced or unsurfaced. Hot-applied asphalt and coal-tar pitch roofs are applied similarly. Hot-applied asphalt roofs use uncoated, saturated felts (except for base sheets and cap sheets); cold-applied roofs use saturated and coated felts and cut-back cements containing a volatile solvent.

##### 4.1.4 Felts

The layers of felts in a built-up roof function primarily to hold the layers of bitumen in place. Generally felts do not materially contribute to the





*Figure 8. Results of poor workmanship in applying built-up roof.*

waterproofness of the roof and are not suitable for exposure to the weather. Built-up roofs are always designated by the number of plies of felt they contain; for example, 3-ply and 5-ply roofs contain 3 and 5 plies of felt respectively. Felts may be: organic-fiber (wool, paper, rag), asphalt-saturated; organic-fiber (wool, paper, rag) coal-tar saturated; glass fiber, asphalt-saturated; asbestos, asphalt-saturated. Asphalt saturated and coated felts are manufactured for use as a vapor barrier. For built-up roofs utilizing glass-fiber felts, a combination base sheet consisting of glass-fiber felt with kraft paper backing is available. Coated felts surfaced with mineral granules are sometimes used for the wearing surface (cap sheets) on built-up roofs. Glass fiber felts should not be used in extremely cold weather (arctic) locations.

#### **4.1.5 Aggregate-Surfaced Roofs**

Aggregate surfacing for built-up roofs serve these important functions. They permit the use of thick surface coatings of bitumen, protect the bitumen from sunlight and heat, and increase the wind and fire resistance of the roofing. Surfacing materials may be gravel, slag, marble, and other suitable materials. Marble or other light colored aggregates may be used to reflect the heat or for aesthetic purposes. Light weight aggregates such as scoria are useful in reducing the load on the roof

structure, for example, on roof decks supported by wood trusses. When crushed stone is used for surfacing, the stone should not have sharp edges. ASTM specification D 1863 covers the quality and grading of crushed stone, crushed slag, and waterworn gravel suitable for use as aggregate surfacing. Other materials should conform to the grading requirements of ASTM specification D 1863 and be opaque to ultraviolet light, hard, and free of dirt or foreign material. Built-up roofs, except those surfaced with promenade tile or similar surfacing are not intended to carry much foot traffic. On roof areas that are subjected to regular traffic, tile surfacing, concrete, wood, or asphalt plank walkways must be provided. Aggregate surfacing must not be used on any built-up roofs near a flight line, as the aggregate can be blown off the roofs and sucked into the aircraft jet engines.

#### **4.1.6 Smooth-Surfaced Roofs**

A smooth surface treatment may be employed in lieu of aggregate surfacing to provide a weathering surface on asphalt built-up roofs where it is necessary to hold roof loads to a minimum, where there is a possibility of surfacing aggregates being blown off and damaging sensitive or critical material and equipment, where required by roof configuration, or other reasons. Smooth-surface treatments include mineral-surfaced cap sheets (roll



*Figure 9. Laying felts mechanically and brooming-in after felt is rolled into hot bitumen.*

roofing) and mopped-on, brushed-on, or sprayed-on asphalt coatings. Clay type asphalt-base emulsions (ASTM D-1227, Type I) may be used as a protective coating for smooth-surfaced asphalt roofs having inclines of not less than  $\frac{1}{2}$  inch to the foot. Emulsions are sometimes reinforced with glass fibers. Aluminum pigmented, solvent type, asphalt coatings (ASTM D-2824) may be used to provide a reflective protective coating on asphalt or metal roofing. Both the emulsion and the solvent type coatings must be renewed periodically, i.e., every 3 to 6 years.

#### **4.1.7 Insulation**

Generally, because of economic and other practical considerations, roof insulation is applied above the roof deck. The various types of insulation are described in current guide specifications for new construction. Most commonly used are the rigid, board-type insulations and the poured-in-place insulating concrete fills. The insulation must have sufficient compressive strength to avoid the possibility of puncturing of the roofing membranes by foot traffic. The thickness of insulation is determined from the heat transmission or V-value

which is required. Steel decks must be provided with a layer of underlayment (board-type insulation or lightweight insulating fill) to bridge between deck ribs and support the roofing membrane. The insulation must have good adherence or fastening to the substrate. Likewise the roofing membrane must be firmly adhered or fastened to the insulation. Roof assemblies utilizing cellular plastic insulations must be carefully checked for compliance to fire protection requirements. While the provision of above deck insulation offers many advantages, it can result in considerable maintenance problems. For example, moisture from condensation or leaks can damage the insulation, result in a loss of thermal insulation value, and cause blisters or other problems in the roof membrane. In arctic areas ( $-20^{\circ}$  F and colder temperature zones) it is preferable to place the insulation beneath the roof deck. A comprehensive discussion of insulation and vapor control can be found in the publication entitled "Manual of Built-Up Roof Systems," written for the American Institute of Architects by C. W. Griffin, Jr., P.E., and available from the McGraw-Hill Book Company.

#### 4.1.8 Vapor Barrier

The purpose of a vapor barrier is to retard the passage of water vapor into the insulation from the interior (warm side) thereby preventing condensation within the insulation. Such would be the case where very high humidity conditions prevail as in a bakery or laundry. A vapor barrier must be continuous to be effective. Suitable vapor barriers include: two layers of 15 pound saturated felt mopped solidly between the layers with bitumen or one layer of double coated felt, polyvinyl sheet or laminate consisting of polyvinyl sheet between plies of reinforced kraft paper, each with all laps sealed. A danger in using a vapor barrier is that it may impede the escape of moisture which may inadvertently get into the insulation during initial construction or through leaks in the roofing membrane or flashing. Because of this the use of a vapor barrier must be carefully considered. The modern theory regarding a vapor barrier states "when in doubt, leave it out."

#### 4.1.9 Venting

Whenever insulation is sandwiched between a vapor barrier and a roofing membrane there is a possibility of a build-up of a vapor pressure within the sandwich relative to the ambient atmospheric pressure which can cause blisters to form in the membrane. Venting should be provided to relieve this build-up of vapor pressure. Venting can be accomplished by means of stack vents or edge vents consisting of a series of slotted openings cut in treated wood nailers at roof edges, parapets or other walls, and at roof expansion joints. Venting is required along the complete perimeter of roof decks or common roof areas.

#### 4.1.10 Fastenings

Sufficient anchorage of roofing membrane, insulation, and underlayment must be provided, by adhesive bond, mechanical fastening, or both, to preclude ply slippage and/or blow-off. Types of

fasteners and anchorage requirements are given in guide specifications and design manuals. Uplift (suction) forces due to wind are generally greatest at edge of the roof. Hence, blow-off of roofing usually commences at the roof edge, the roofing membrane and sometimes the insulation then being peeled back towards the center of the roof. This points up the need for adequate fastening of the gravel stop, and roofing membrane and insulation near the edges of the roof. This also points up the need for a wood nailing strip securely fastened to the deck structure at the roof edge. For wood or other decks with cracks or openings, consideration must be taken of the up-lift of the membrane due to wind pressure from below. For arch type roofs with steep slopes, the use of the up-and-over, "vertical" application can be used advantageously to preclude ply slippage. Nailing is not generally required for asphalt built-up roofs on concrete decks with inclines of less than 1 inch per foot or for coal-tar built-up roofs on concrete decks with inclines of less than ½ inch per foot.

#### 4.1.11 Roof Drainage

Roof decks for built-up roofing should be sloped for drainage at least ¼ inch to the foot. An adequate number of drains of sufficient size must be provided and must be located at low points of roof to preclude ponding. Drains, gutters, leaders, and storm drains must be sized for storm-design conditions. Structures with continuous parapet walls must include scuppers or overflow drains.

#### 4.1.12 Designation

Built-up roofs suffer by being designated as 10-, 15-, or 20-year roofs. Too often these designations are interpreted to mean that the roof will require no maintenance for the stated period. Roofs that are not maintained will, in all probability, require replacement at or before the end of the stated period, while those that are maintained properly can be expected to serve well beyond the period.

## Section II. ROOF DECKS FOR BUILT-UP ROOFS

#### 4.2.1 Wood Decks

(1) Wood decks should be low moisture content tongued and grooved lumber or may be plywood with exterior glue of thickness and nailing appropriate for rafter spacing and total roof load. Best results will be obtained with plywood ½ inch and thicker.

(2) Deck should be dry when roofing is applied.

(3) At least two nails should be driven flush per 6 inches width of board at each rafter. Annular ringed or spirally grooved nails can be used to reduce troublesome "nail popping."

(4) Roof deck must be smooth with no irregularities. Existing decks which do not present a smooth surface may be overlaid with ¼ inch thick exterior grade plywood.

(5) Knot holes and cracks wider than ¼ inch

between boards should be covered with sheet metal.

(6) A dry, red rosin, separation sheet should be provided between wood deck and roofing membrane.

#### **4.2.2 Poured Concrete and Gypsum Decks**

(1) Deck must be aged, dry, smooth, free from frost or freezing effects, properly graded to drains, and free from loose material.

(2) If deck is uneven, high spots must be removed or low spots filled with portland cement or gypsum mortar.

(3) Nailing strips in concrete, when required, must be treated to resist rot, properly keyed into the concrete, and flush with the surface.

(4) Concrete decks must be primed prior to application of asphalt.

#### **4.2.3 Precast Concrete Units**

(1) Deck must be dry, smooth, free from frost or freezing effects.

(2) Deck units must be aligned to eliminate humps or ridges between adjacent units.

(3) Use cement mortar to level inequalities and fill cracks in the deck.

#### **4.2.4 Precast Gypsum Units**

(1) Protect units stored on the job from rain or snow. Store metal-edge gypsum plank on edge, not more than three tiers high, with ample ventilation.

(2) Gypsum decking applied each day must be covered with roofing that day or otherwise protected.

(3) Use only gypsum mortar to fill cracks and level inequalities in the roof deck.

(4) Examine old decks from beneath prior to reroofing. Such decks in contact with water deteriorate rapidly. Replace deteriorated areas.

#### **4.2.5 Steel Decks**

(1) Deck must be dry, firm, tight, free from rust, grease, or any loose material.

(2) All steel decks should be shop coated or painted.

(3) Lightweight fill or board-type insulation must be provided over steel decks to form a firm, plane surface.

(4) Fasteners for suspended items should not be hung from the steel roof deck.

(5) Steel decks must be sufficiently rigid to insure that flexing under the weight of men or equipment does not result in breaking the bond between the steel deck and the vapor barrier and/or insulation.

### **Section III. STORAGE, HANDLING, AND APPLICATION OF MATERIALS**

#### **4.3.1 Weather Conditions**

Except in emergencies, roofing work should be accomplished only during dry weather. Preferably it should be accomplished in other than the winter months. The inspector or foreman should insure that built-up roofing work is not started until the ambient temperature is above 40° F. and that the surfaces on which roofing is to be applied are free of ice, frost, or moisture. During cold weather roofing felts should be stored inside at a temperature above 50° F. prior to use.

#### **4.3.2 Asphalt and Coal-Tar Pitch**

Drums of asphalt and coal-tar pitch should be stood on end and protected from the weather during storage. Asphalt and pitch should be cleaned of extraneous matter and broken up in pieces before placing in the kettle. For safety, pieces should be slipped rather than dropped into melted bitumen. Asphalt-base emulsions contain water and must be stored at temperatures above plus 40° F.

*4.3.2.1 Temperature of Bitumen.* The inspector should insist that the temperature of the melted bitumen be controlled. The properties of both

asphalt and coal-tar pitch may be changed adversely by overheating. Consequently, in some cases overheating the bitumen may result in a reduction in the useful life of a built-up roof while in others may be a major factor in roof slippages. Modern heating kettles are usually equipped with a thermometer, but these are frequently broken or so covered with bitumen as to be illegible. The inspector should be provided with a thermometer. Asphalt should not be heated above 450° F. and should normally be not lower than 350° F. when poured or mopped on a roof. If asphalt with a softening point of 150° F. or lower is used, the maximum kettle temperature is 375° F. and the minimum temperature for application is 300° F. Coal-tar pitch should not be heated above 400° F. and should not be poured or mopped at temperatures under 350° F. Dense yellow fumes from the heating kettle is proof that the coal-tar pitch is too hot. Once the bitumen has been overheated it must be discarded and not used.

*4.3.2.2 Application of Bitumen.* The final coating of asphalt or coal-tar pitch on aggregate-surfaced built-up roofs should always be poured rather than mopped to insure sufficient (60 to 80



Figure 10. Surface coating of hot bitumen should be poured, not mopped.

pounds per square) bitumen for embedding the aggregate surfacing (fig. 10). To determine whether aggregate surfacing is embedded properly, the inspector should include a broom as part of his regular equipment (fig. 11). Emulsions or aluminum pigmented coatings may be applied by brush, mop, or spray.

### 4.3.3 Felts

**4.3.3.1 Storage.** Felts stored on the job must be protected from the weather. It must be realized that these felts, although they are described as "saturated" with asphalt or coal-tar pitch, will still absorb considerable moisture if exposed to it. Felts that contain moisture are certain to result in blistered built-up roofs. Felt rolls should be stood on end, not in contact with the ground.

**4.3.3.2 Application of Felts.** When felts are applied, they should preferably be rolled into the hot asphalt or coal-tar pitch that has been applied with a mop not more than three feet ahead of the roll. Sufficient asphalt or pitch (20 to 25 pounds per square) should be present between the plies of felt to insure that, in no case, is felt touching felt. Immediately after the felt is rolled into the hot bitumen, it should be "broomed in" with a stiff bristle broom (fig. 9). Any small blisters or buckles remaining should be slit with a knife and smoothed

out with the broom. If blisters or buckles longer than 8 inches in any dimension are present, the felt should be removed and relaid. The plies of felt should be laid shingle fashion. Generally, the layers of felt should be applied at right angles to the slope of the deck. Cant strips should be provided where the roof intersects vertical surfaces such as parapet walls. Felts should extend to the top of the cant strip. The objective of the cant strip is to keep the metal flashing above the highest water line wherever possible. Generally, felts should not be mopped directly to precast gypsum, cast-in-place gypsum, or insulating-concrete surfaces. The first ply should be nailed only to prevent shrinkage or structural cracks which may develop in the substrate from damaging the roofing membrane. On nonnailable decks with inclines that require the nailing of felts, treated wood nailing strips must be provided. At eaves and rakes, the bottom layer of felt should be turned back over the remaining plies to form an envelope which will prevent bitumen from dripping down the outside of the building. Separate layers of roofing felt may be used to provide the bitumen stop or a metal bitumen stop can be used.

### 4.3.4 Surfacing

Surfacing aggregates for built-up roofs should be dry and free from dust since wet or dusty surfacing



Figure 11. Insufficient bitumen to embed aggregate surfacing.

materials will not bond well with the bitumen. If wet they should be dried by piling over a heated metal drum with open ends. If roofing work must be done in cold weather, this method may be used to heat the surfacing material to secure proper embedment. If, in reroofing work, surfacing materials are to be reused, they must be screened to remove fines, dirt or other foreign material. The embedment of light weight aggregates may be improved by rolling with a light roller.

#### 4.3.5 Insulation and Underlayment

**4.3.5.1 Storage.** Insulation should be stored under cover and be kept dry at all times. No more insulation should be installed in a single day than can be covered with roofing on that day. At the end of each day's work the exposed edges of insulation or underlayment should be provided with temporary cutoffs of mopped-on felts. The cutoffs are removed when work is resumed.

**4.3.5.2 Application.** Since the application of insulation and/or underlayment varies with the

different kinds of decks, the kinds of insulation or underlayment, and the use of the structure, general instructions only will be given here. For detailed instructions, reference should be made to current guide specifications for new construction, design manuals, and to instructions furnished by the manufacturers. Units of insulation or underlayment should be laid in parallel courses with horizontal joints broken, in moderate contact with adjoining units without forcing, and cut to fit neatly against adjoining surfaces. Tests indicate that felts are stronger in the "in the machine" direction than in the "across machine" direction. Therefore, it is preferable to lay the insulation with the continuous joint parallel to the short dimension (slope) of the roof and to lay the felt parallel to the long (eave) dimension of the roof. Continuous joints between underlayment units should not occur over the fluted openings in steel decks. Insulation or underlayment may be applied in solid or spot moppings of bitumen, with special adhesives, by nailing, or with special fasteners, as appropriate. If light-weight fills are used as insulating materials, provision must be

made to allow dissipation of mixing water. Thermosetting light-weight insulation fills are available which do not require water for mixing and can be reroofed over immediately. It is important that these fills be dry before roofing is applied. On decks of limited expanse, light-weight fills may sometimes be used advantageously to provide additional roof slope. All decks over which insulation is to be applied must be provided with wood edge strips at least 6 inches wide and of the same thickness as the insulation at all open edges and elsewhere where metal flashing must be fastened to the roof.

#### **4.3.6 Vapor Barriers**

For detailed instructions on the application of vapor barriers, reference should be made to the latest guide specifications for new construction and to manufacturers' literature. The vapor barrier must be continuous and unbroken. The vapor barrier must not be turned over edges of insulation board adjoining vented gravel stops or other vented edges. Felt vapor barrier plies should be extended at edges of the roof and folded back to form an envelope to prevent dripping of bitumen. Adhesive for use with polyvinyl-sheet vapor barriers should be nonflammable and compatible with contact surfaces. Insulation applied to polyvinyl sheets shall be laid in nonflammable adhesive.

### **Section IV. DETERMINING TREATMENT FOR BUILT-UP ROOFS**

An analysis of the data furnished in the historical records and that listed on the inspection forms will assist in determining what treatment, if any, the roof is to receive. If necessary, cutouts of roofing and insulation will be examined to verify the condition of the roofing assembly. Walls, parapets and the underside of the roof deck should be examined. As-built drawings and specifications provide essential information. In addition to the above, consideration must be given to such factors

as the kind of structure, whether permanent or temporary, its occupancy; the kind of roof, its age, and the frequency at which leaks occur. A roof on a structure designated for temporary retention should be given only the minimum treatment necessary to keep it leakproof during the period of retention. A roof on a structure for permanent retention should be considered in the light of the prolonged use of the structure and should be given the best maintenance, repair, or reroofing possible.

### **Section V. MAINTENANCE METHODS FOR BUILT-UP ROOFS (TREATMENT PRIOR TO FAILURE)**

#### **4.5.1 General**

Asphalt products should always be used in the maintenance of asphalt built-up roofs, and coal-tar pitch products in the maintenance of coal-tar pitch built-up roofs. Asphalt and coal-tar pitch are not compatible so that contact between the two should be avoided whenever possible. In the text that follows, the terms "bitumen" and "bituminous" are used to indicate asphalt when asphalt roof maintenance is discussed and coal-tar pitch when coal-tar pitch roofs are discussed. *Exception:* While asphalt and coal-tar pitch should not be mixed in heated form, they may be used together under certain conditions. These conditions are where asphalt coated base sheets and plastic base flashings composed of asphalt-saturated felts and mineral surfaced roll roofing embedded in asphalt-base bituminous cement are used in constructing coal-tar built-up roofing.

#### **4.5.2 Maintenance of Aggregate-Surfaced Built-Up Roofs (Treatment Prior to Failure)**

##### *4.5.2.1 Bare Areas (Small Areas).*

*4.5.2.1.1 Bituminous Coating Exposed.* When the bituminous coating is exposed (fig. 12), scrape the gravel or slag from the bare area and broom clean. While it is sometimes possible to apply hot asphalt directly to the old asphalt and attain satisfactory adhesion, it is generally better to apply a thin coat of asphalt primer conforming to ASTM Specification D41. This will insure that a satisfactory bond is attained. Use a thin coat of primer only and allow to dry. A primer is not required over coal-tar pitch. Cover the bare area with hot bitumen poured on at a rate of 60 pounds per square for asphalt and 75 pounds per square for coal-tar pitch, and while hot embed clean gravel or slag. Do not attempt to apply hot bitumen over slag or gravel surfacing since bitumen will not adhere

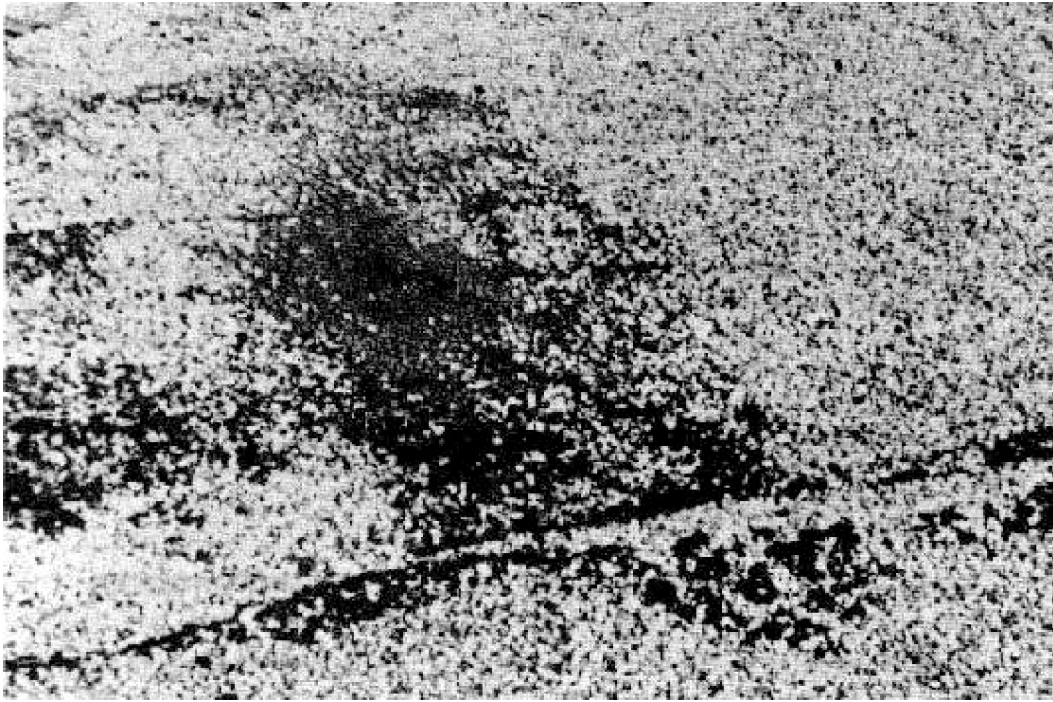

Figure 12. Bituminous coating exposed due to loss of aggregate.

(fig. 13) and water will penetrate under the bitumen.

**4.5.2.1.2 Felts Exposed.** If the bituminous coating has weathered to the extent that the top ply of felt is exposed (fig. 14) but is still in good condition (not disintegrated), brush dust and dirt from the exposed area and, in the case of asphalt roofs, apply a thin coat of asphalt primer and allow to dry. Apply a flood coat of bitumen and aggregate surfacing as described in preceding paragraph. Coal-tar pitch roofs are treated similarly except that the primer is omitted.

**4.5.2.2 Small Blisters and Buckles.** If bare, treat small blisters and buckles as bare areas; otherwise disregard them (fig. 15).

**4.5.2.3 Bituminous Coating Weathered Severely Over Entire Roof Area.** When bituminous coating is weathered severely over the entire roof area, remove as much of the bituminous coating and aggregate surfacing as possible. Removal is best accomplished in cool weather. When large roof areas are involved, the use of mechanical equipment to remove the bituminous coating and surfacing material is easier and more economical than removal by hand methods. Replace disintegrated felts and repair damaged areas, blisters and buckles as described hereinafter under paragraph 4.6, "Repair Methods-Built-Up Roofs Treatment Following at Least Partial Failure." Sweep off loose material. In the case of asphalt, weathered surfaces should be primed. Recoat with

hot bitumen poured on at a rate of 60 pounds per square for asphalt and 75 pounds per square for coal-tar pitch. Into the hot bitumen embed 400 pounds of gravel or 300 pounds of slag per square.

### **4.5.3 Maintenance of Smooth-Surfaced Roofs (Treatment Prior to Failure)**

**4.5.3.1 Felts Exposed (Small Areas).** Same as for aggregate-surfaced, built-up roofs, except that 20 to 25 pounds of asphalt should be mopped per square and the aggregate surfacing omitted.

**4.5.3.2 Small Blisters and Buckles.** If felts are exposed, treat as described for exposed felts, aggregate surfaced, built-up roofing, applying 25 pounds of asphalt per square and omitting aggregate surfacing. If felts are not exposed, disregard small blisters and buckles.

**4.5.3.3 Asphalt Coating Weathered Severely Over Entire Roof Area.**

**4.5.3.3.1 General Discussion.** Smooth surfaced, asphalt built-up roofs, in which the surface topping is relatively thin and is exposed directly to the weather, usually show definite alligating of the surface coating within 3 to 5 years. Alligating is always most severe where the asphalt coating is thickest. If "alligating" is allowed to proceed, it will develop into cracking (fig. 16). Once the surfacing coating is cracked, water enters the membrane, leaks may appear and the roofing deteriorates at a rapid rate. Consequently, maintenance before cracks appear is necessary.

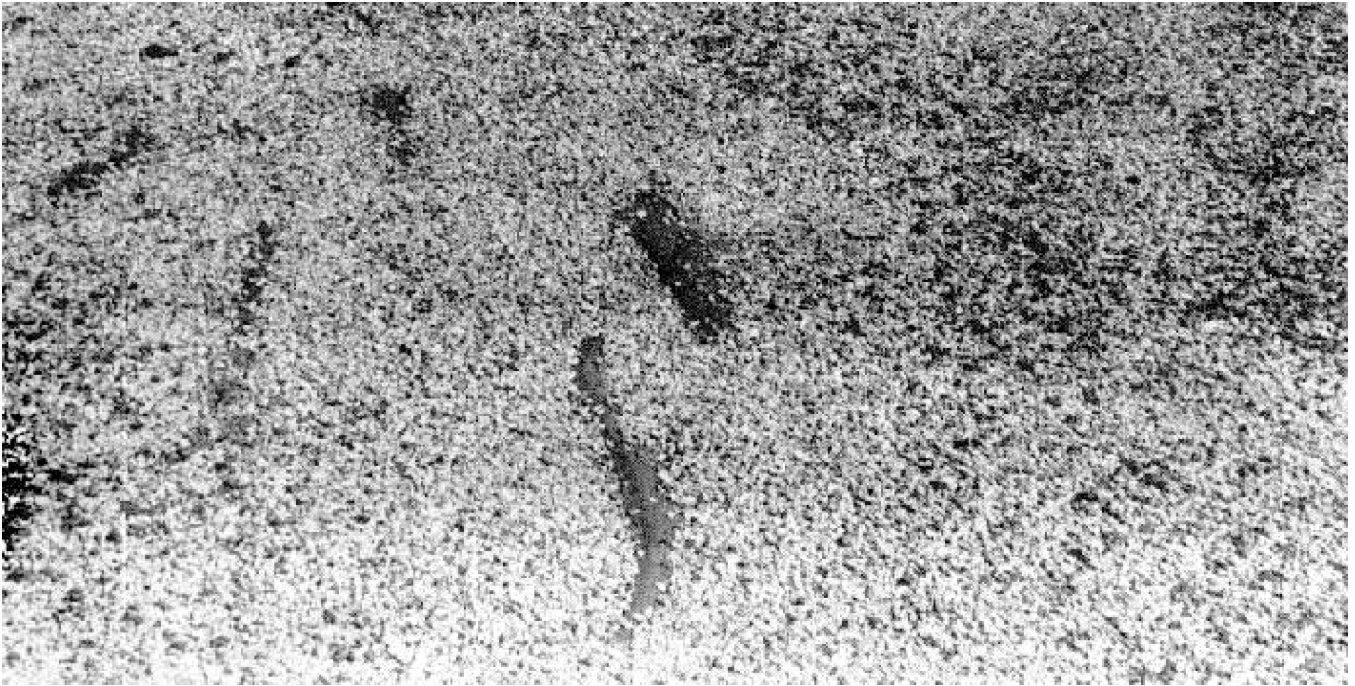



*Figure 13. Hot bitumen poured on unprepared surface — note lack of adhesion.*



*Figure 14. Felts exposed and weathered due to loss of aggregate and bituminous coating.*



*Figure 15. Small blisters or buckles — when bare should be treated as bare areas (para 4.5.2.1).*

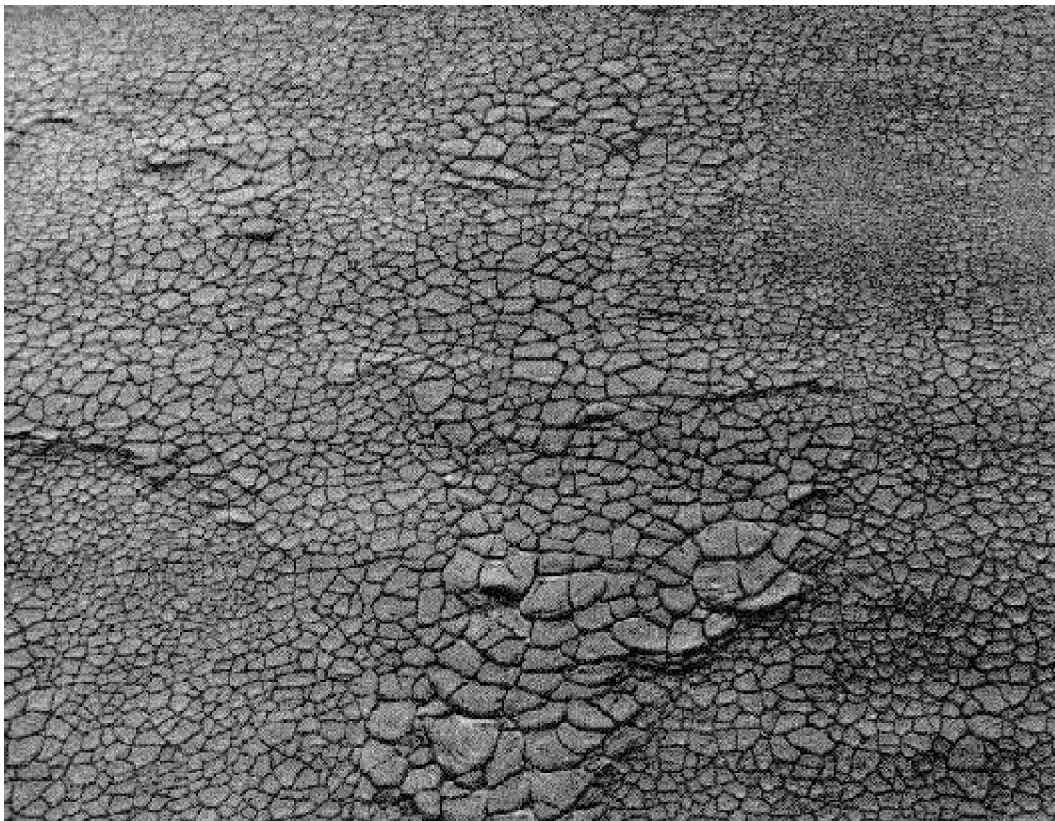

*Figure 16. Severe alligatoring on thick coating of asphalt.*

**4.5.3.3.2 Treatment.** Remove all loose dust and dirt by sweeping, vacuuming or air blast. Apply one coat of asphalt primer conforming to ASTM Specification D 41. A thin coat only is desired,

applied preferably by brushing, to avoid excess primer. After primer is dry, apply one of the following:

- (1) Clay type asphalt emulsion conforming to



Figure 17. Alligating and cracking of a cold coating over alligatored asphalt surface after 1 year exposure.

Military Specification MIL-R-3472, "Roof Coating; Asphalt-Base Emulsion" by brush or spray at a rate of 3 gallons per square (ASTM D-1227, Asphalt-Base Emulsions for Use as Protective Coatings for Built-up Roofs, Type I). Chemical type should not be used. The clay type is available with a reinforcing of chopped glass fibers.

(2) Asphalt-base roof coating meeting Federal Specification SS-A-694 "Asphalt, Petroleum (Coating, Brushing and Spraying Consistency)," by brush or spray at a rate of 3 gallons per square (ASTM D-2823, Asphalt Roofing Coatings). If a reflective coating is desired, an asphalt-based aluminum roof coating conforming to ASTM Specification D-2824 may be applied by brush or spray.

(3) Hot-mopping asphalt conforming to ASTM Specification D-312, "Asphalt for Use in Constructing Built-up Roof Coverings," of type suited for the slope of the roof, at a rate of 20 to 25 pounds per square.

*Note.* If an emulsion coating is to be applied to such surfaces, dust and dirt may be washed off with a stream of water from a hose. The emulsion may be applied to a damp, but not a wet surface. Coatings applied over alligatored and cracked surfaces also tend to alligator and crack (fig. 17). This tendency increases as the coating thickness is built-up; when recoating, therefore, coating thicknesses should be properly controlled. Since the asbestos felts are constructed mainly of inorganic materials, exposure to the weather is much less serious than with organic felts. Manufacturers of asbestos felts generally do not recommend recoating asbestos felt roofs at any time.

## Section II. REPAIR METHODS FOR BUILT-UP ROOFS (TREATMENT FOLLOWING AT LEAST PARTIAL FAILURE)

### 4.6.1 Aggregate Surfaced, Built-Up Roofs

See paragraph 4.5.1 regarding compatibility of asphalt and coal-tar pitch.

4.6.1.1 *Felts Exposed and Partially Disintegrated-Small Areas (fig. 18).* Scrape off all surfacing material to a distance at least 2 1/2 feet beyond the area of disintegrated felts. Remove disintegrated felt layers and replace them with new 15-pound bituminous-saturated felts of approximately the same size and mopped in place with hot bitumen. Apply at least two additional layers of 15-pound saturated felt. Extend the edges of the first ply 9 inches beyond the area of

disintegrated felts, and the second ply 18 inches, mopped on with hot bitumen. Apply a pouring of hot bitumen to the repaired area at a rate of 60 pounds per square for asphalt and 75 pounds per square for coal-tar pitch and into it, while hot, embed clean gravel or slag.

4.6.1.2 *Roof Membrane Cracked (Split).* Treat as described for disintegrated felts, except that it is usually only necessary to mop on at least two plies of 15-pound saturated felt, followed by the heavy pouring of bitumen, with slag or gravel surfacing. If splitting is extensive or occurs in a pattern the cause should be ascertained and corrective action

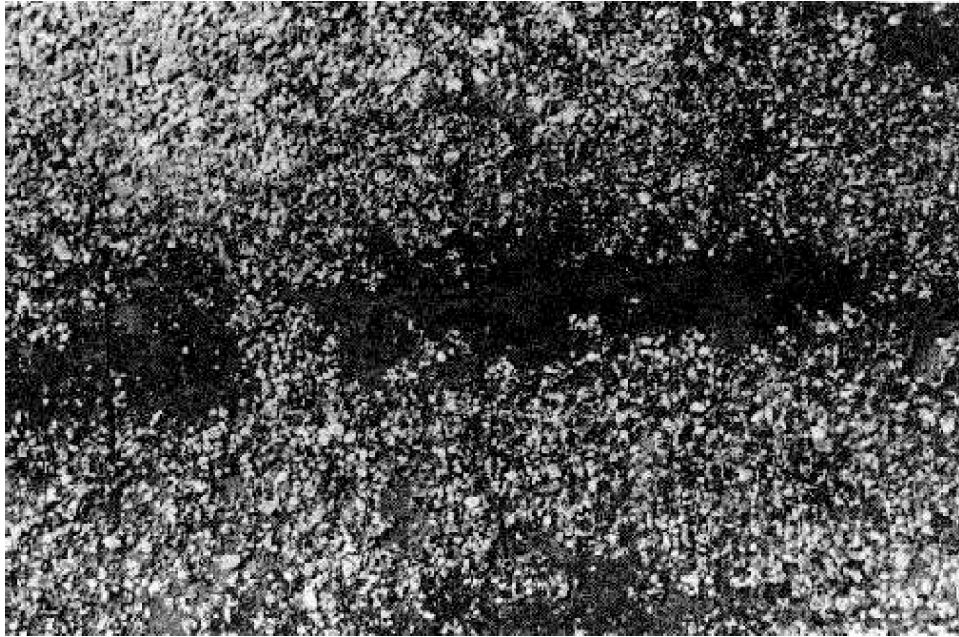

Figure 18. Coating weathered off small areas — felt exposed and partially disintegrated..

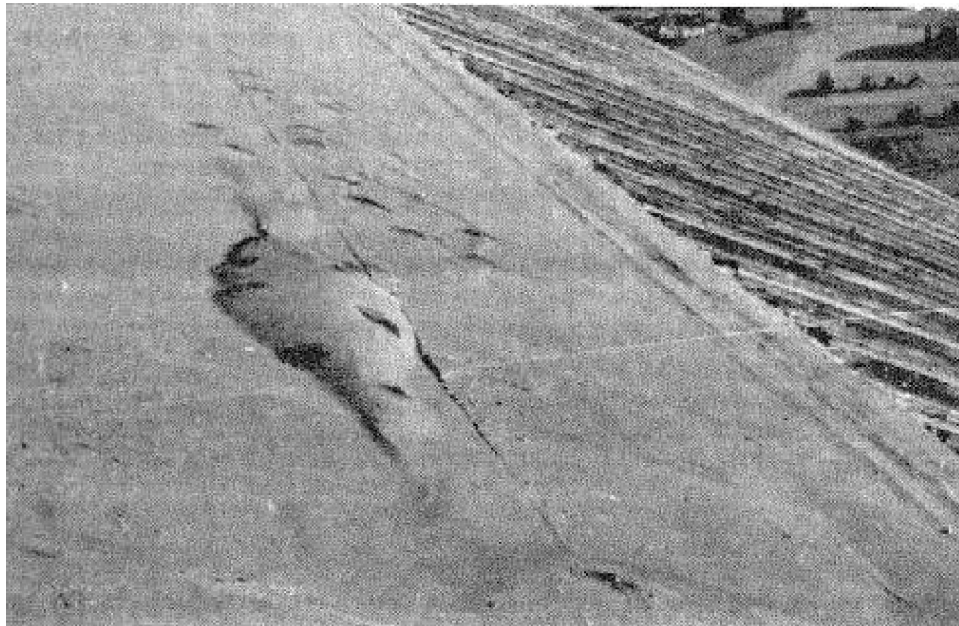

Figure 19. Large blister on smooth-surface roof.

taken to prevent recurrence especially if reroofing is required. Some causes of splitting are: lack of provision for expansion and contraction, ply slippage, extension of cracks in substrate up through roofing membrane.

**4.6.1.3 Large blisters or Buckles that have Cracked to Allow Water to Penetrate.** Blisters or buckles (fig. 19), though large, if intact, will not leak. Only if the felts disintegrate or are cracked should they be repaired. Scrape off all surfacing material to a dry felt surface at least 2½ feet beyond the edge of the blister or buckle. Make two

cuts at right angles to each other extending 12 inches beyond the edge of the blister or buckle. Fold back the four corners of the membrane and allow to stand until thoroughly dry. When dry, apply a liberal mopping of bitumen (hot is preferred but cold cement may be used), fold down the four corners of the membrane and press them firmly into the hot bitumen. Apply at least two additional layers of 15-pound saturated felt mopped on with hot bitumen and extending at least 9 inches and 18 inches respectively beyond the ends of the cuts. Apply a pouring of hot bitumen at a rate of 60



Figure 20. Felts disintegrated and disbonded – reroofing is mandatory.

pounds per square for asphalt and 75 pounds per square for coal-tar pitch, and while hot, embed gravel or slag.

**4.6.1.4 Fishmouths.** Scrape off all surfacing material to a distance at least 12 inches beyond the affected area. Cut the fishmouth and cement down the loose felts with hot bitumen or cold plastic cement. Apply at least two layers of 15-pound saturated felt mopped on with hot bitumen. Extend the first ply at least 6 inches beyond the end of the cut felt and 6 inches below the lap edge. Extend the second ply 6 inches beyond the first ply. Apply a heavy pouring of hot bitumen and into it, while hot, embed gravel or slag.

**4.6.1.5 Felts Exposed and Disintegrated in Numerous Areas (fig. 20).** Under this category no definite criteria can be established to determine whether the existing membrane should be repaired by adding plies of felt or whether the old membrane should be removed entirely and a new one applied. The condition of the membrane (determined from cut-outs) should largely govern, but the historical record of the roof will be of definite assistance in making a decision.

#### 4.6.1.5.1 Cases Where Repairs Are Indicated.

- (1) Roof has not reached its expected life; that is, roughly, for a 5-ply roof, 20 to 25 years; a 4-ply roof, 15 to 20 years; and a 3-ply roof, 10 to 15 years.
- (2) Base felts are in sound condition and are not waterlogged.
- (3) Insulation, if present, is sound and dry.
- (4) Leaks that have developed are few in number and are not serious.

#### 4.6.1.5.2 Cases Where Reroofing is Mandatory.

- (1) Roof has exceeded its expected life with little or no maintenance.
- (2) Felts have disintegrated and/or are disbonded; entire membrane is in poor condition.
- (3) Insulation, is wet and/or disintegrated.
- (4) Numerous leaks of a serious nature have developed in the membrane.

**4.6.1.5.3 Repairing by Applying Additional Plies of Felt.** In applying additional plies of felt to an existing built-up roof, the best practice is not to mop the additional felts solidly to the existing membrane. It is better to isolate the repair

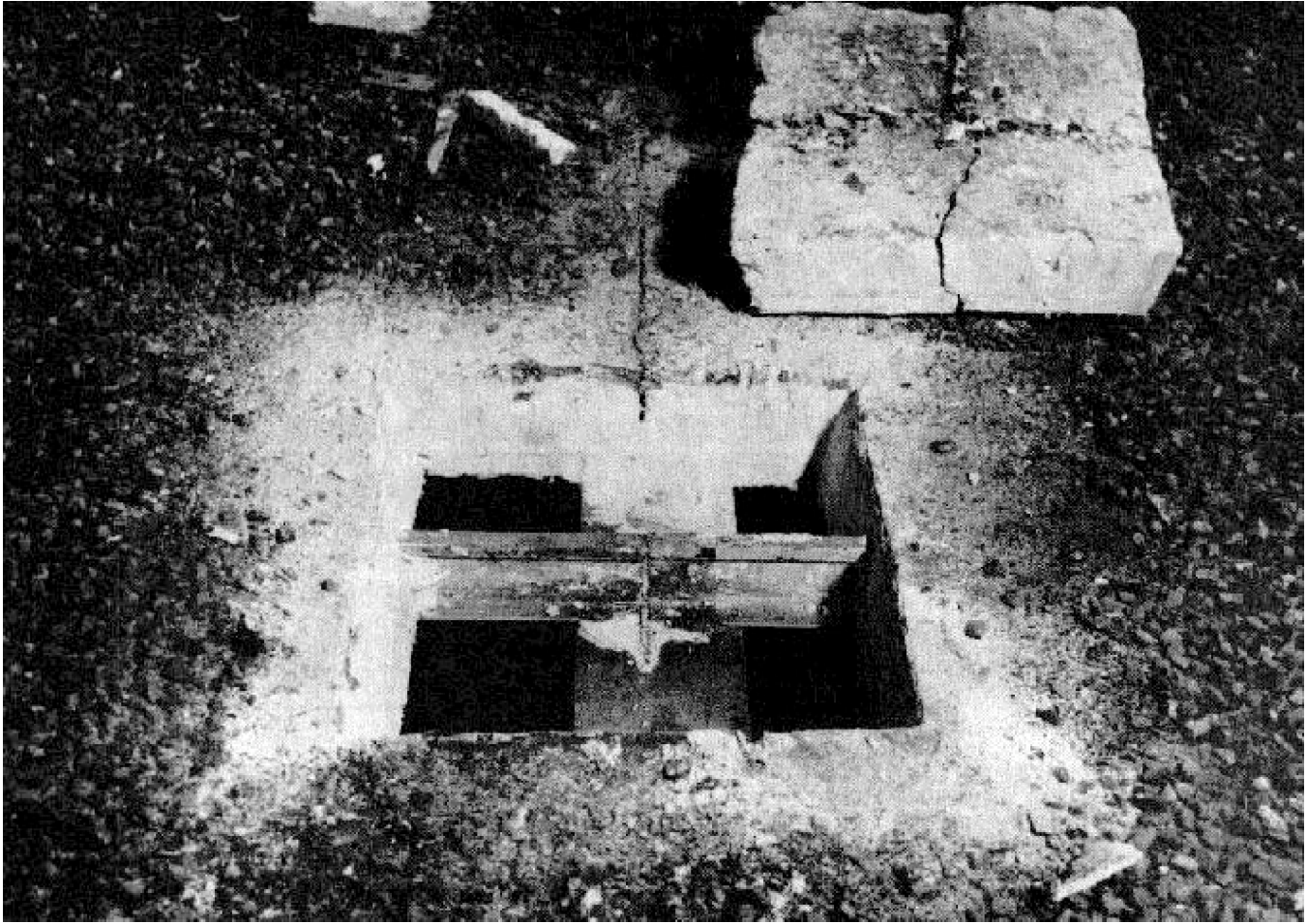

Figure 21. Test cut in gypsum deck — crack extends up through roofing membrane mopped directly to deck.

membrane from the old membrane with a "dry" felt layer, spot or strip mopped, or nailed, or preferably by ½ inch of roof insulation strip mopped, and if possible, nailed through the old membrane to the roof deck. If the slope of the roof is greater than 1 inch per foot, some provision must be made for fastening the felts and the insulation. The use of insulation is desirable because it effectively isolates the old membrane from the new one and provides a smooth surface free from irregularities for the new membrane. The new membrane should contain not less than 3 plies of felt. While the application of additional plies of felt is sometimes practical and advantageous, a word of caution about the danger of impounding moisture in old roofing and insulation is appropriate. If moisture is entrapped, blisters are likely to form and result in early failure of the additional plies of felt. It is imperative that the existing roofing and insulation be dry if additional plies of felt are to be applied. Other factors which also should be considered are: Cost; advantages of correcting roof deck, insulation, and flashing deficiencies when a membrane is replaced;

desirability of keeping roof loads to a minimum; problem of maintaining a watertight roof while reroofing is being accomplished; dust problem on stored material when roofing is removed over wood sheathed decks; contemplated retention and use of structure.

*4.6.1.5.4 Preparation of Existing Roofing to Receive New Membrane--All Types of Decks.* Remove aggregate surfacing, bituminous coating and all loose and disintegrated felts. Refer to paragraph 4.5.2 on "Maintenance of Aggregate Surfaced Built-Up Roofs; Treatment Prior to Failure." Repair blisters, buckles, cracks and fishmouths as indicated above, omitting final pouring of bitumen and aggregate surfacing material. Provide cant strips at intersection of roof with vertical surfaces where required.

*4.6.1.5.5 Application of New Membrane Over Existing Membrane on Concrete Decks.*

(1) *Saturated Organic or Glass Fiber Felt with Insulation.* Mop solidly with hot bitumen ½ inch of roof insulation to the existing membrane. Follow with at least 3 plies of 15-pound saturated

felt mopped solidly to the insulation and to each other with hot bitumen. Finish with a surface pouring of hot bitumen at a rate of 60 pounds per square for asphalt and 75 pounds per square for coal-tar pitch into which gravel or slag is embedded at a rate of 400 pounds of gravel or 300 pounds of slag per square. Use only organic base sheet and felts in localities with extremely cold temperatures; glass fiber felts contract more and tend to break, and therefore should not be used.

(2) *Saturated Organic or Glass Fiber Felt Without Insulation.* Spot or strip mop with hot bitumen one ply of saturated felt to the existing membrane. Follow with at least 2 plies of saturated felt mopped solidly and finished as described in the preceding paragraph.

(3) *Asphalt and Asphalt-Saturated Asbestos Felt — With and Without Insulation.* Proceed as described for organic or glass fiber felts using asphalt-saturated asbestos felts, except that the finish coat should consist of asphalt emulsion meeting Military Specification MIL-R-3472, applied at a rate of 3 gallons per square.

4.6.1.5.6 *Application of New-Membrane Over Existing Membrane on Wood Decks.* Proceed as described for concrete decks except that insulation and felt should always be nailed over wood decks in addition to the mopping recommended when applying a new membrane over concrete. Spot or strip mopping may be omitted when the new membrane is applied directly to the old, the first ply being simply nailed.

4.6.1.5.7 *Application of New Membrane to*

*Existing Membrane on Gypsum Decks.* Treat as described for wood decks. If the roof deck shows cracks on the under side, or if the existing roofing is cracked, the use of insulation under the new membrane is required to prevent extension of the cracks up through the new roofing (fig. 21).

4.6.1.5.8 *Application of New Membrane over Existing Membrane on an Insulated Roof.* First make certain that the old insulation is dry and not disintegrated. If the insulation is not thoroughly dry or if it shows any evidence of disintegration, the existing roofing and insulation should be removed down to the roof deck and a new roof applied. If satisfied that the insulation is in good condition, remove aggregate surfacing and apply an additional layer of ½ inch insulation, followed by 3 layers of 15-pound saturated felt, mopped on and finished as described for concrete decks.

## 4.6.2 Smooth-Surfaced Asphalt, Built-Up Roofs

Treatment of smooth-surfaced built-up roofs following partial failure is the same as for aggregate-surfaced built-up roofs except no removal of aggregate surfacing will be required, bitumen will always be asphalt, and the top coat should be as outlined in paragraph 4.5.3.3.2. The top coat for all built-up roofs of asbestos felts should be clay type asphalt emulsion conforming to Military Specification MIL-R-3472 applied at a rate of 3 gallons per square.

## Section VII. REROOFING

### 4.7.1 General

A thorough analysis of the roof assembly should be made to determine the most feasible method of reroofing. If failure was premature, the cause should be determined and eliminated if possible. Selection of a specification for new roofing should be made mainly on the basis of the expected future use of a structure.

### 4.7.2 Specifications

Reroofing should, to the extent feasible, be accomplished in accordance with standard military guide specifications for new construction. Manufacturer's specifications provide helpful guidance in instances where military guide specifications are not applicable. It is reiterated that since guide specifications are essentially written for new construction they must be carefully adapted for each project to suit the conditions encountered.

### 4.7.3 Drawings

Complete contract drawings should be provided for built-up roofing projects. The drawings must clearly show what is to be left in place, what is to be removed, what, if anything, may be reused, and what is to be provided new. It is particularly important that each type of flashing installation (e.g. gravel stops, gutter and spouts, drains, base and cap flashings, expansion joints, curbs, copings, etc.) be individually designed and fully detailed on the drawings. Flashing or other details must not be left to the imagination or discretion of the contractor.

### 4.7.4 Preparation of Deck for Reroofing

Prepare the deck for reroofing as follows:

- (1) Remove the old membrane entirely.
- (2) Restore the deck to as nearly "new" condition as practicable.

(a) On wood decks remove all rotted boards, replace with sound boards and renail loose boards. If necessary to provide a smooth deck, an overlay of exterior grade plywood may be applied.

(b) On cracked gypsum or concrete decks, ½ inch of board type insulation may be applied if deemed necessary to prevent cracks in the deck from extending upward through the new membrane.

#### **4.7.5 Corrective Measures**

Replacement of built-up roofing need not be a replacement "in kind." It must include measures to eliminate design deficiencies that exist and trouble areas. Also, improved methods or techniques should be used where appropriate. Examples of such measures include: Provision of additional expansion joints; installation of fill to provide roof slope; installation of additional drains; provision of cant strips; overlayment of decks with plywood or insulation; installation of walkways.



## CHAPTER 5

# ASPHALT-SHINGLE ROOFING

---

### Section I. DESCRIPTION AND GENERAL DISCUSSION

#### 5.1.1 References

Specifications for shingles and allied materials are listed in the appendix. For a complete description of asphalt shingles, including manufacturing methods and methods of application, it is urged that the following publication be obtained: "Manufacture, Selection and Application of Asphalt Roofing and Siding Products," published by, and available on request from, the Asphalt Roofing Manufacturers Association, 757 Third Avenue, New York, N.Y. 10017.

#### 5.1.2 General Description

Asphalt-shingle roofing is manufactured in single or multiple units of roofing felt saturated and coated on both sides with asphalt and surfaced on the weather side with mineral granules. The asphalt coating may or may not contain fine mineral stabilizer. The surfacing materials on asphalt shingles serve the same functions as those of built-up roofs and, in addition, provide a choice of colors and color blends. The surfacing materials (granules) are either natural products such as slate or trap rock or other mineral products with a ceramic coating. Opaqueness to solar radiation is a most important requirement for roofing granules. Shingles are available in a wide range of colors. Shingles surfaced with light colored granules have good light reflectance and should be used on air conditioned buildings. Asphalt shingles are available in a number of forms or shapes, the most common being the square-butt, strip type. Other types are hexagonal strip, individual shingles laid by the American, Dutch lap or hexagonal methods and lock-down shingles of various types.

#### 5.1.3 Coverage

One of the most important considerations in the selection of asphalt shingles is "coverage," the term used to describe the number of layers of roofing furnished by a particular type of shingle in place. Single-coverage shingles provide but one layer of material over a large proportion of the roof area;

double-coverage shingles provide two layers over most of the roof area; triple coverage, three layers, etc. The better the coverage, other considerations being equal, the better the service that may be expected.

#### 5.1.4 Weight

Weight is another important consideration in the selection of asphalt shingles. Shingles should weigh a minimum of about 230 pounds (Type 235) pounds per square (100 square feet) when applied.

#### 5.1.5 Headlap

Headlap is important in determining the waterproofness of shingles. Headlap may be defined as the distance water must travel upward from the outside to the inside of a roof, assuming there are no breaks in the fabric. With square butt strip shingles, headlap is the distance a shingle in any course overlaps a shingle in the second course below it. The greater the head-lap, the better the waterproofness.

#### 5.1.6 Exposure

The exposure of a shingle is defined as the maximum distance the shingle is exposed to the weather, disregarding the space between individual shingles and the cut-out sections of square-tab strip shingles. Coverage, headlap and exposure are interdependent; as the exposure is increased, the headlap and coverage are decreased correspondingly. As the exposure is increased, the possibility of wind damage is increased.

#### 5.1.7 Fire Resistance

Asphalt shingles for military use should meet the requirement of Underwriters Laboratories, Inc. publication UL 55B, "Class C Asphalt Organic-Felt Sheet Roofing and Shingles." Class C indicates that they are effective against light fire exposures. Several proprietary strip shingles are available with a Class B or a Class A fire resistance rating,

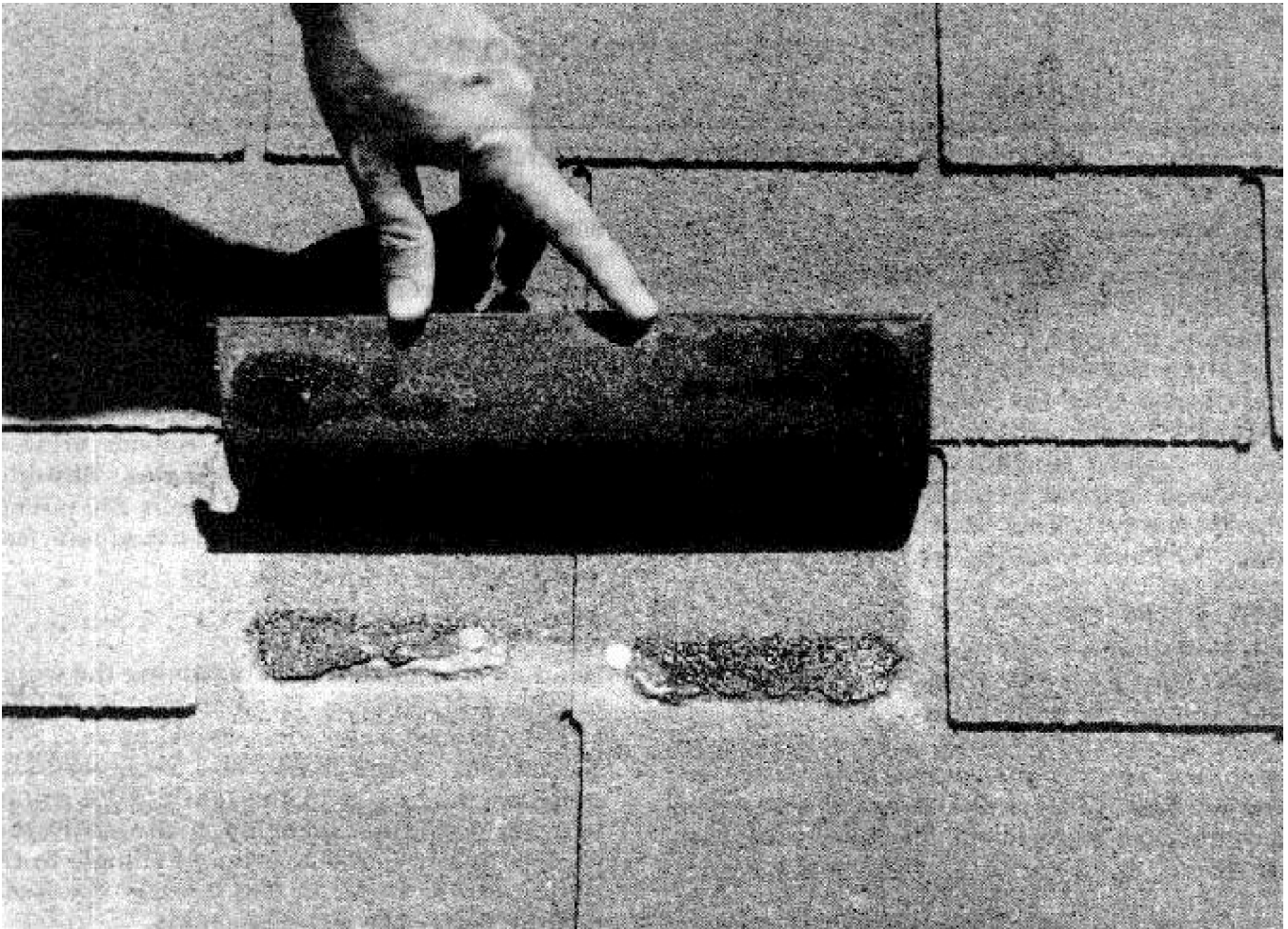

*Figure 22. Wind-resistant asphalt strip shingles with factory applied spots of adhesive.*

indicating that they are effective against increasingly severe fire exposure. Class C shingles are normally specified for military facilities.

### **5.1.8 Square-Butt Strip Shingles**

Shingles covering wide ranges of weight and coverage are available. However, the organic-fiber felted square butt-strip shingle, 12 by .36 inches in size, with an exposure of .5 inches and weighing approximately 2.30 pounds per square applied (Type 235), is the accepted asphalt shingle for roofs on military structures. Shingles may be uniform thickness or thick-butt type; however, the uniform thickness type is preferred. Other types of shingles may be used only for spot repair to match existing roofing. Subsequent sections will therefore deal primarily with square-tab strip shingles, although kinds of decks, methods of handling and

storage, weathering characteristics, and methods of maintenance and repair apply almost equally to all types of asphalt shingles.

### **5.1.9 Wind-Resistant Shingles**

Wind-resistant shingles are available which have spots or strips of adhesive factory applied to each tab (fig. 22). The adhesive is activated as the shingle is applied on the roof. Wind-resistant shingles should always be specified. As an option to using shingles with factory applied adhesive, tabs of shingles may be fastened down with field applied spots of bituminous cement as described in paragraph 5.5.1. This procedure is generally the more expensive choice. Class C, wind-resistant shingles should meet the requirements of UL 55B and UL 79D, "Guide Test Method for Wind-Resistant Shingles."

## Section II. ROOF DECKS FOR ASPHALT-SHINGLE ROOFS

Wood decks for asphalt-shingle roofs should be of well-seasoned sheathing lumber, nominal 1 inch in thickness, not more than 6 inches wide and preferably tongued and grooved, or of plywood with exterior glue, not less than ½ inch thick. Sheathing boards should be fastened to each rafter with two nails to provide a smooth, even surface. Any knot holes, resinous areas or loose knots should be covered with sheet metal. The deck should be covered with an underlayment of type 15

asphalt-saturated felt prior to laying the shingles. Coated felts should not be used as an underlayment for shingles since they constitute a good vapor barrier and might cause condensation or frost to form at the roof deck. Attic spaces under asphalt shingled roofs should be vented in accordance with accepted practice. Where the underside of the roof rafters is lined to form an exposed ceiling, continuous vents should be provided at both the eave and the ridge for effective venting.

## Section III. STORAGE AND HANDLING OF ASPHALT SHINGLES

### 5.3.1 Handling Shingles

Asphalt shingles should be handled carefully at all times to prevent damage. Particular care should be exercised during extremes of temperatures. When hot they may be torn rather easily and when cold, the asphalt coating becomes brittle and may be cracked if the shingle is bent. Bundles should be lifted by placing the hands underneath, not by the wires. They should not be thrown or dropped and hooks should not be used.

### 5.3.2 Storage of Shingles

Shingle bundles stored in warehouses or on the job should not be piled so high that the bottom shingles will be damaged. Bundles should be stored not more than 5 to 8 bundles deep. In any case, stacks

of shingles should not be more than 3½ feet high. Shingles with factory-applied spots of adhesive should not be stored in the sun or in warm areas as the heat may cause the shingles to stick together and prevent separation of the shingles at time of application. Shingles should not be stacked directly on the floor of a warehouse or on the ground. They should be stacked on planks spaced so that the shingles do not sag. Shingles stored on the job must be protected from the weather. If water comes in contact with the nonweather surface of the shingles, the thin asphalt coating on the back surface may permit some water to be absorbed by the felt base and blistered shingles will result. Contact with oils or solvents must be avoided.

## Section IV. DETERMINING TREATMENT FOR ASPHALT-SHINGLE ROOFS

### 5.4.1 Weathering

Asphalt-shingle roofs that are applied properly usually require no special maintenance or repair treatments. Shingles normally last from 10 to 20 years depending on the climate with very little change in appearance. The first indication of normal weathering is the loss of mineral surfacing granules, slight at first, but accelerating as the loss of granules expose more of the asphalt coating to the weather (fig. 23). No definite periods can be ascribed for the various phases of weathering because they will vary with the direction of exposure, the climate and the slope of the roof. Weathering is more rapid in hot, humid climates; on southern and western exposures and on low pitched roofs (fig. 24). Asphalt-shingle roofs with at least double coverage will usually not leak, even if most of the granular surfacing has disappeared. The first indication of leakage in thick-butt shingles appears

at the cut-out area. However, without the surfacing, weathering proceeds rapidly, the shingles become brittle and more vulnerable to wind damage, so that large bare areas are an indication that the roof will soon need attention (fig. 25).

### 5.4.2 Clawed Shingles

Some asphalt shingles, particularly those manufactured during the approximate period 1950-62, after being on the roof for a number of years exhibit a phenomena which has been termed "clawing" (fig. 26). The clawing phenomena is attributed primarily to a lack of sufficient asphalt coating on the underside of the shingle. Shingle specifications were revised in 1962 to reduce the incidence of the clawing condition. At this time shingle weights were increased; the Type 210 shingle was replaced by the Type 235 shingle.

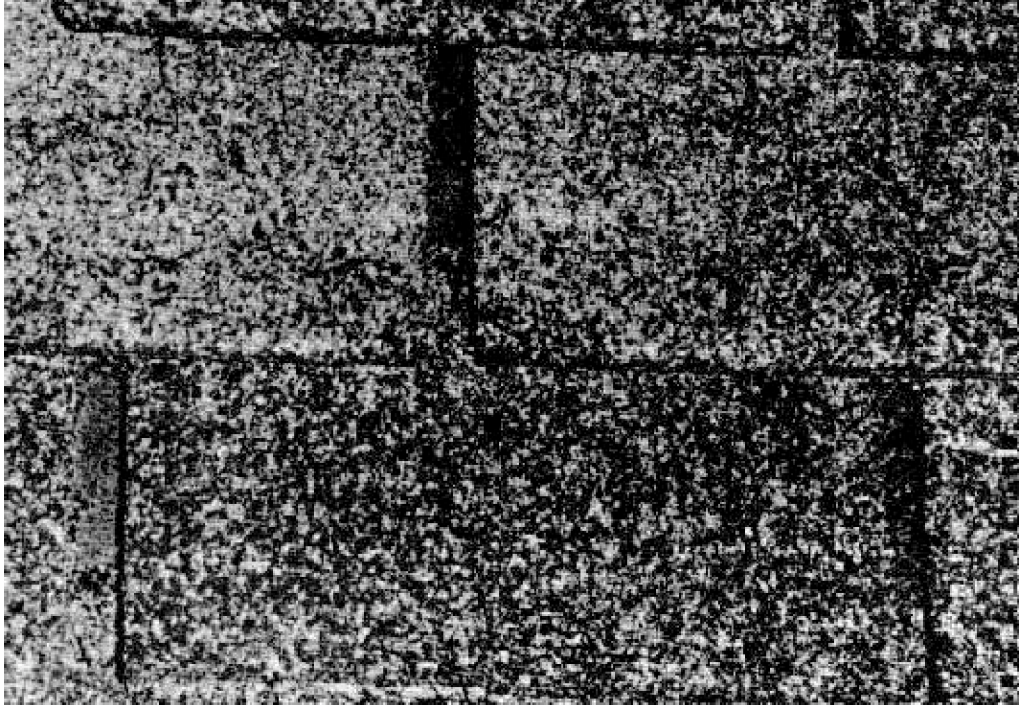

*Figure 23. Loss of mineral surfacing granules due to normal weathering.*



*Figure 24. Difference in weathering of asphalt shingles on southern and eastern exposures.*

Clawed shingles should not be replaced merely for the sake of appearance. Although the shingles may be severely clawed, in all probability the roof will not leak and replacement is not required until such time as the shingles become deteriorated. However, clawing does shorten the useful life considerably.

### **5.4.3 Recoating**

The recoating of weathered asphalt shingles is not recommended for the following reasons:

- (1) Shingles that have weathered to the stage that recoating would seem to be indicated are probably so brittle that they are likely to be

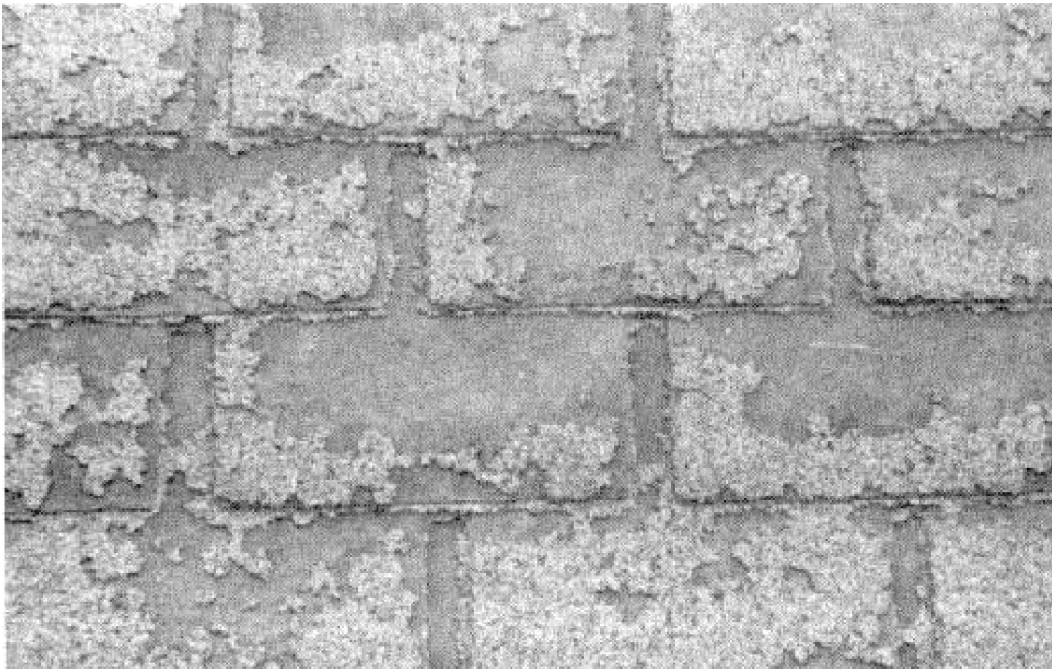

*Figure 25. Severe loss of mineral granules and coating asphalt due to weathering.*



*Figure 26. Clawed asphalt strip shingles.*

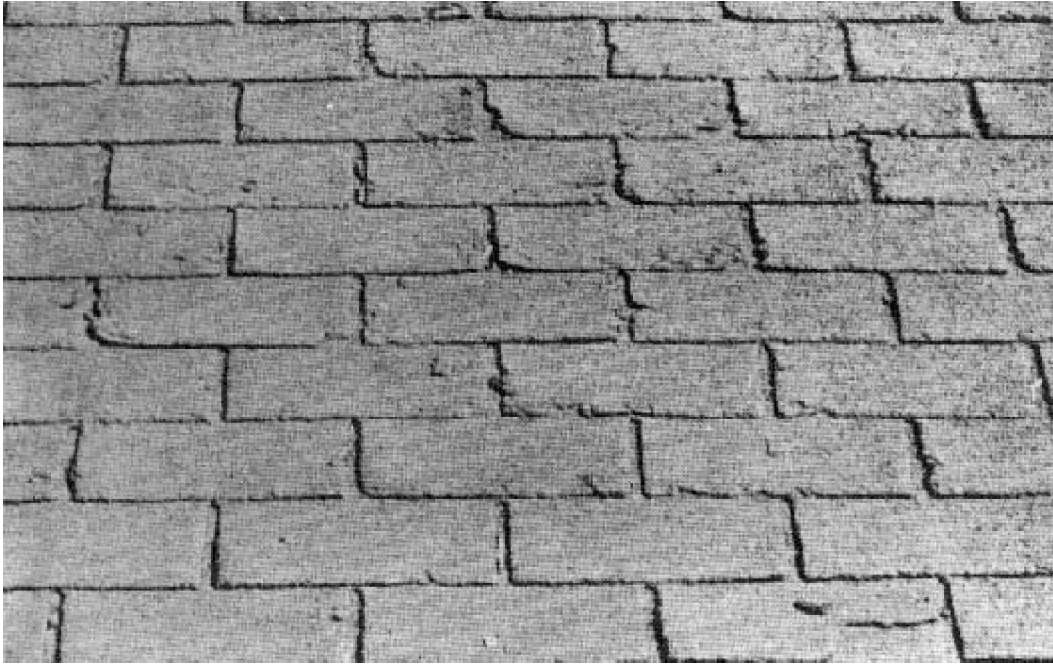

Figure 27. Recoated asphalt shingles — note damage resulting from brittleness.

damaged severely by the recoating operation (fig. 27).

(2) Further, the unequal weathering of the exposed tabs will result in an unequal absorption of the coating material, thereby causing the coated tabs to curl unless great care is

taken to cement tightly all three edges of all exposed tabs.

(3) Experience has shown that the cost of recoating and sealing the edges of the shingle tabs is such that reroofing is the more economical procedure.

## Section V. MAINTENANCE AND REPAIR METHODS FOR ASPHALT-SHINGLE ROOFS

In asphalt-shingle roofs no sharp distinction can be drawn between maintenance and repair work. Maintenance and repair methods for asphalt-shingle roofs are therefore combined.

### 5.5.1 Maintaining Roofs Having Improperly Nailed Shingles

The defect that is found most frequently in the application of square-tab strip shingles is the improper placement of nails, that is, nailing too near the top of the shingle rather than  $\frac{1}{2}$  to  $\frac{3}{4}$  inch above the top of the cut-out portions (fig. 28). Too-high nailing of shingles should be corrected by placing a spot of quick setting asphalt plastic cement under the center of each tab (two spots for each tab of 2-tab shingles) and pressing the tab down firmly. The spot of cement should be not less than 1 square inch in area when pressed flat (fig. 29). Asphalt plastic cements are readily obtainable and are satisfactory for this purpose. Approximately  $\frac{1}{2}$  gallon of cement is required per square of shingles. The shingle tabs should not be bent up farther than necessary to place the cement. No attempt should be made to renail shingles in the

proper locations since the bending required may damage the shingle tabs.

### 5.5.2 Maintaining Asphalt-Shingle Roofs in Areas of Strong Winds

The cement treatment described above should also be used to prevent wind damage to shingles without factory applied adhesive that are nailed correctly but are located in areas where strong winds are prevalent.

### 5.5.3 Maintaining Asphalt-Shingle Roofs Damaged by Hail

Severe hail storms may damage asphalt-shingle roofs beyond repair, particularly if the shingles have been exposed for a number of years (fig. 30). With such damage, both layers of shingles are broken, the roof will leak severely and reroofing is mandatory. Severe damage such as shown in figure 31, where the asphalt coating and surfacing granules have been removed from numerous small areas, but where the shingles are not broken, will not cause the roof to leak. However, the life of a roof so damaged will be shortened materially. Maintenance is not practicable since the cost would

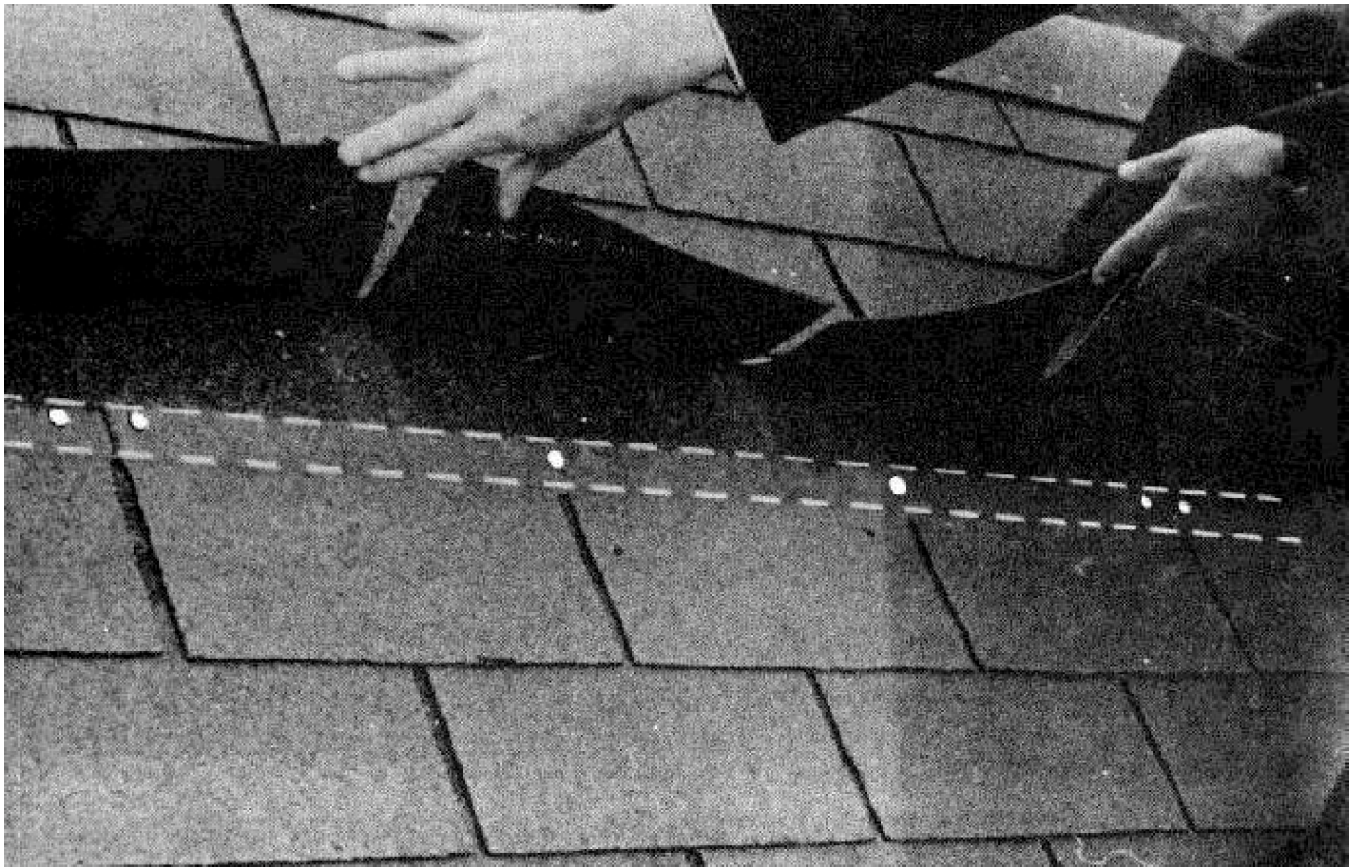

Figure 28. Proper method of nailing asphalt shingles.

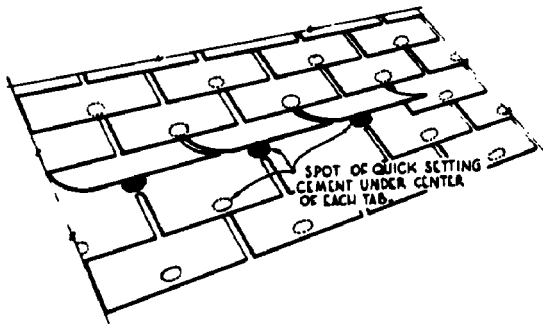

Figure 29. Location of cement under tabs.

probably equal that of a new roof. Minor hail damage, where only occasional areas from which the coating and surfacing granules have been loosened may be repaired by covering the bare areas with asphalt-base roof coating, plastic cement, or clay type asphalt emulsion. (See para 4.5.3.3.2 for description.)

#### 5.5.4 Renewing Rotted Eaves Boards

The roof sheathing boards at the eaves are

frequently rotted before the roof shows any signs of deterioration, because of failure to provide a proper drip edge. In such cases the first three or four courses of shingles should be removed and deteriorated sheathing replaced.

In replacing the shingles, the starter strip and first course of shingles should project at least  $\frac{3}{4}$  inch beyond the eave line to form a drip, or in lieu thereof, a metal drip edge should be provided. Particular care should be taken not to damage the old shingles when removing nails to join the new roof section with the old one.

#### 5.5.5 Installing Drip Edge at Rake

Cases where shingles have been applied without a proper overhang of  $\frac{1}{4}$  to  $\frac{3}{8}$  inch at the rake and where no metal drip edge has been applied may be corrected, before the roof sheathing has deteriorated, by removing carefully any nails holding the shingles at the rake and applying a metal drip edge. The shingles should then be renailed and all of the shingle tabs adjoining the rake cemented as described in paragraph 5.5.1.



*Figure 30. Hail damage showing broken shingles — reroofing mandatory.*

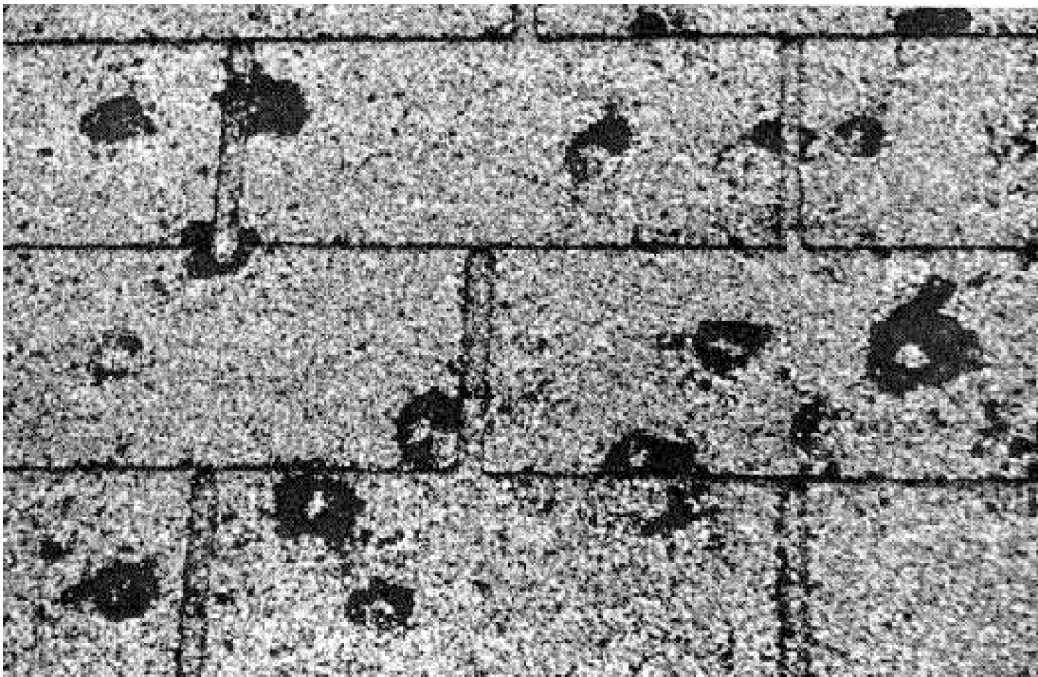

*Figure 31. Hail damage showing shingles unbroken.*



## Section VI. REROOFING WITH ASPHALT SHINGLES

### 5.6.1 General

Asphalt shingles may be used for reroofing over asphalt-shingle roofs and over smooth and mineral-surfaced asphalt roll roofing. However, the better practice is to remove the existing roof covering. Among the reasons for removal are: an opportunity is given to correct deficiencies in the roof deck, such as warped or rotted framing and sheathing; better nailing is provided; shingles applied on a smooth surface generally render better service than on an uneven surface; moisture in the old roofing will enter the new shingles and cause small surface blisters, and the appearance of the reroofing job is better. In cases where asphalt shingles have been applied over an existing roof, and reroofing is again necessary, the two roofs should be removed without question. The reasons for removal given previously apply with even greater force in such cases. No attempt should be made to apply asphalt-shingle roofing over existing metal, slate or asbestos-cement roofs because of difficulties in nailing. Asphalt shingles can be applied over old wood shingles. However, the amount of labor and material involved in the preparation normally does not warrant leaving the wood shingles in place.

### 5.6.2 Preparing Deck for Reroofing With Asphalt Shingles

*5.6.2.1 When Existing Roofing Is Removed.* To restore the roof deck to as nearly "new" condition as possible —

- (1) Remove all protruding nails and re nail sound sheathing where necessary.
- (2) Remove rotted or warped sheathing boards or delaminated plywood and install new decking.
- (3) Cover all large cracks, knot holes and resinous areas with sheet metal.
- (4) Repaint ferrous metal drip edges and other flashings that are in good condition or remove badly corroded metal flashings and install new ones of nonferrous metal.
- (5) Remove old roll roofing flashings. Install new base flashings of nonferrous metal or roll roofing, and new nonferrous metal counter flashings.
- (6) Fill in with wood strips of the same thickness as the existing sheathing the spaces between spaced sheathing to which a wood shingle, slate or tile roof had been applied. An alternate method which might be more economical, considering labor costs, is to install plywood over the existing spaced sheathing.

- (7) Sweep all loose debris from the roof deck.

#### *5.6.2.2 When Existing Roofing Remains.*

(1) *When Reroofing Over Asphalt Roll Roofing:*

- (a) Remove all loose and protruding nails.
- (b) Cut all wrinkles and buckles and nail cut edges securely to the roof deck.
- (c) Repaint ferrous metal drip edges and counter flashings that are in good condition.
- (d) Install new nonferrous metal or roll roofing base flashings and new metal counter flashings in accordance with new construction specifications where necessary.
- (e) Install new nonferrous metal or roll roofing valley flashings.
- (f) Sweep all loose debris from the roof deck.

(2) *When Roofing Over Asphalt Shingles:*

- (a) Remove all loose or protruding nails.
- (b) Nail down or, preferably, cut away the butts of all curled or lifted shingles.
- (c) Treat flashings as described in (1) above.
- (d) Sweep all loose debris from the roof deck.
- (e) Cut away the butts on clawed shingles.

(3) *When Reroofing Over Wood Shingles:*

- (a) Remove all loose and protruding nails.
- (b) Nail down or cut off corners of warped shingles.
- (c) Replace decayed or missing shingles with new ones.
- (d) Cut back shingles at eaves and rake far enough to apply 1 inch by 4 inch wood strips securely nailed.
- (e) Apply beveled wood strips approximately four inches wide over each course of wood shingles. The thick side of the strips should be as thick as the butts of the wood shingles, with the other side feathered to negligible thickness.
- (f) Treat flashings as described in (1) above.
- (g) Sweep all loose debris from the roof deck.

### 5.6.3 Applying Asphalt-Shingle Roof

*5.6.3.1 General.* Apply asphalt shingles in accordance with current specifications for new construction except that when an asphalt-shingle roof is applied over an existing asphalt-shingle or roll-roofing roof, nails must be of sufficient length to penetrate the sheathing at least  $\frac{3}{4}$  inch to provide adequate anchorage. Nails of  $\frac{1}{4}$  inch length will generally suffice.

5.6.3.2 *Low Slope Roofs*. For roofs having a slope of less than 4 inches per foot, special application methods are used. The entire roof should have an underlayment consisting of two-layers of asphalt saturated felt (type 15). That portion of the felt underlayment which extends from the eave up the roof to a point 24 inches from the inside face of the exterior wall should be cemented together with a continuous layer of plastic bituminous cement applied at a rate of about two gallons per 100 square feet. The purpose of this procedure is to prevent leakage from ice dams which might form along the eaves causing a backup of water. Shingles for low slope roofs should be of the wind-resist- ant type with factory applied spots of adhesive.

5.6.3.3 *Eaves Flashing*. Eaves flashing should be provided in low temperature zones regardless of roof slope. Eaves flashing may consist of a double layer of felt underlayment with a solid coating of bituminous cement applied between the layers as described in paragraph 5.6.3.2, above, or for roof slopes exceeding 4 inches per foot, it may consist of roll-roofing with all laps fully cemented. In

localities where there is a possibility of heavy concentrations of ice forming along the eaves to the extent that the roof may be damaged, a sheet-metal eaves flashing should be provided; in this instance, the gutter is omitted.

5.6.3.4 *Valley Flashings*. Valley flashing may be open sheet metal type, open roll roofing type, or closed woven type. These types are described in detail in current guide specifications and in the publication "Manufacture, Selection, and Application of Asphalt Roofing and Siding Products" which is referenced in paragraph 5.1.1. Since drainage concentrates at the valleys, this is a vulnerable area for leakage. Careful attention must be given to the design and installation of valley flashing so that a smooth unobstructed path is provided to quickly drain away the water. For further discussion of valley flashings, see paragraph 12.3.

5.6.3.5 *Windy Areas*. Wind-resistant shingles must be specified for use in localities subject to high winds. The use of wind-resistant shingles is encouraged in all localities. See paragraph 5.1.9.

## CHAPTER 6

### ASPHALT ROLL ROOFING

#### Section I. DESCRIPTION AND GENERAL DISCUSSION

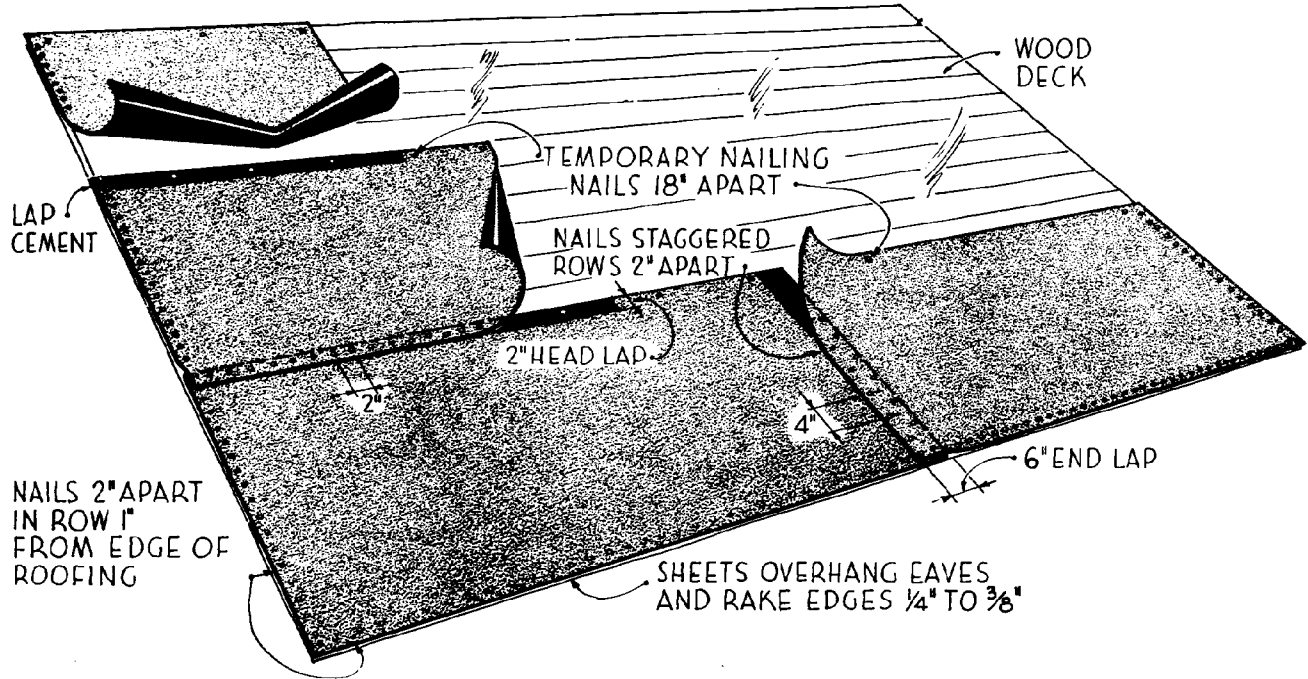

Figure 32. Exposed nail application of roll roofing parallel to the eaves.

#### 6.1.1 General

Asphalt roll roofing is roofing in sheet form composed of roofing felt saturated, and coated on both sides, with asphalt which generally contains fine mineral stabilizer. Asphalt roll roofing is available smooth-surfaced or mineral surfaced.

#### 6.1.2 Smooth-Surfaced

Smooth-surfaced roll roofing is not as durable as mineral-surfaced roll roofing and is normally not used as single layer roofing on military structures. It should only be used on temporary structures where the roofing will be expected to last only for a relatively short time. Application is usually by the exposed nail method with 2 inch cemented laps. It may, however, be laid by the concealed nail method with cemented laps not less than 3 inches wide.

#### 6.1.3 Mineral-Surfaced

Mineral-surfaced roll roofing is composed of organic, glass fiber, or asbestos roofing felt. It is surfaced on the weather side with mineral granules embedded in the asphalt coating. The nonweather side may be dusted with fine mineral matter to prevent sticking. Mineral-surfaced roll roofing is marketed in rolls 36 feet long, in the following styles: with the entire surface covered with granules; with a 2- or 4-inch bare lapping edge; and with a 19-inch bare lapping edge, the latter being distinguished as "wide-selvage" roofing. Roofing with the entire surface covered with granules is intended to be laid with a 2-inch lap and exposed nails (fig. 32). Those roofings with bare lapping edges are intended to be laid with cemented laps the width of the lapping edge and with "blind" nailing, that is, with one edge of the sheet of

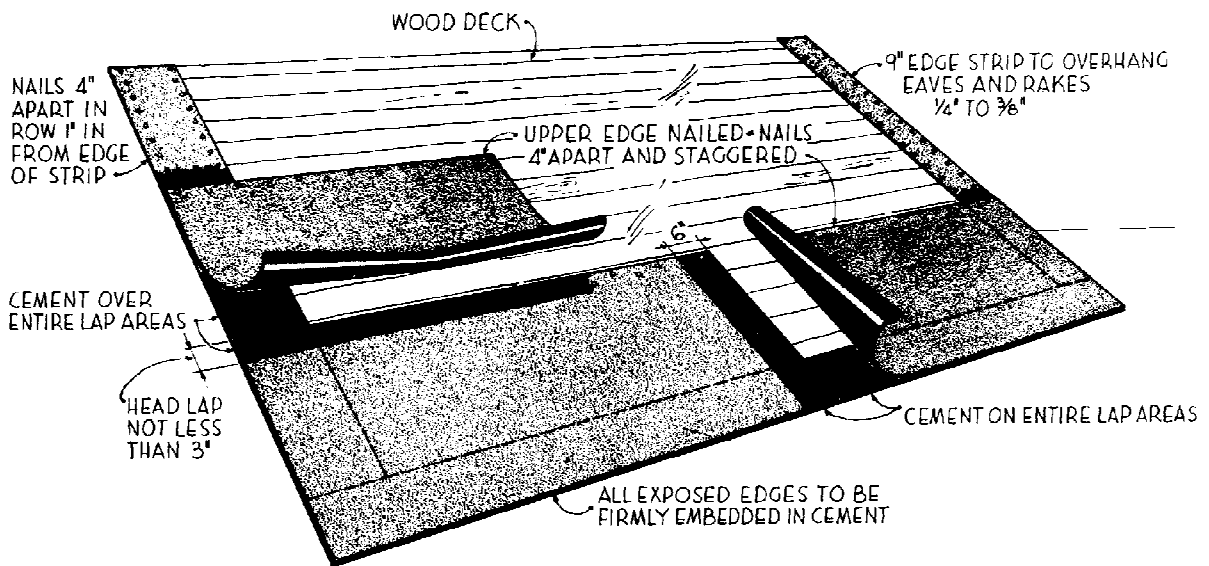

Figure 33. Application of roll roofing by concealed nail method parallel to the eaves.

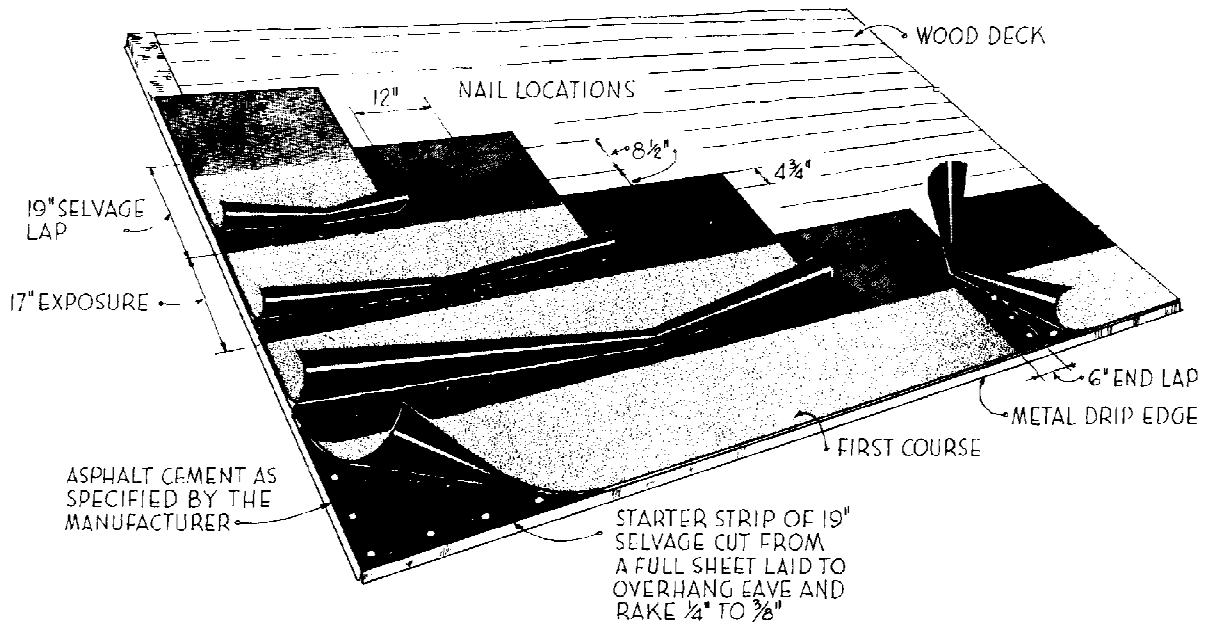

Figure 34. Application of double coverage (wide selvage) roll roofing parallel to the eaves.

roofing nailed and the other fastened only with cement, the nails being covered by the cemented lap (fig. 33). This method of application is preferred because it largely eliminates the "popping out" common with exposed nails. Wide-selvage roofing (fig. 34) provides double coverage over the entire roof area. The wider the lap, the better the service that may be expected from the roofing. Either hot asphalt or cold application asphalt adhesive is used for cementing wide-selvage

roofing. Mineral-surfaced roll roofing lapped not more than 4 inches and with laps cemented may be used on slopes of 3 inches or more per foot; wide-selvage roofing may be used on slopes as low as 2 inches per foot. For emergency construction these slopes may be reduced to 2 inches per foot and 1 inch per foot, respectively. See table 1. With all types of roll roofing, the steeper the slope, the better the service that may be expected, both in waterproofness and weather resistance.

### 6.1.4 Fire Resistance Rating

Mineral-surfaced roll roofings and smooth-surfaced asbestos-felt roll roofings qualify for the class C fire resistance rating of the Underwriters' Laboratories Inc., which indicates that they are effective against

light fire exposures. Asbestos-felt sheet coverings are available which qualify for class B and class A fire resistance rating which indicates that they are effective against moderate and severe fire exposure, respectively.

## Section II. ROOF DECKS FOR ASPHALT ROLL ROOFING ROOFS

Roof decks for asphalt roll roofing roofs should be

the same as for asphalt-shingle roofs (chap 5, sec II).

## Section III. STORAGE AND HANDLING OF ASPHALT ROLL ROOFING

Asphalt roll roofing should be handled carefully at all times, but particularly during extremes of temperature. It is softened at high temperatures and embrittled at low temperatures. Asphalt roll roofings stored in warehouses or on the job should

be stood on end off the ground. If several tiers are to be stored one on top of the other, boards should be placed between the tiers to prevent damage to the ends of the rolls. Roll roofings stored on the job must be protected from the weather.

## Section IV. DETERMINING TREATMENT FOR ASPHALT ROLL ROOFING ROOFS

### 6.4.1 Leaky Seams

Leaks at the seams of smooth and mineral-surfaced roll roofings, applied with 2-inch laps and exposed nails, are the most common roll roofing failure. These leaks are caused principally by inadequate lapping, cementing or nailing of the roofing, buckling of the roofing at the seams, and loose nails.

### 6.4.2 Smooth-Surfaced

Smooth-surfaced asphalt roll roofings, being used normally under austere circumstances, should receive only the minimum amount of maintenance or repair that will keep them leakproof. The first effect of normal weathering on smooth-surfaced roll roofing is the loss of the fine mineral matter used to prevent sticking in the rolls. The coating asphalt, being exposed directly to the weather,

deteriorates more rapidly than that of mineral-surfaced roofing. Recoating with clay-type asphalt emulsion or other suitable coating is usually required within 3 to 5 years. Recoating will be required earliest in hot, humid areas and on buildings such as kitchens and washrooms where excessive moisture conditions prevail.

### 6.4.3 Mineral-Surfaced

Weathering of mineral-surfaced roll roofing is similar to that of asphalt shingles, that is, normal weathering proceeds slowly and is first evidenced by the loss of granular surfacing. Recoating of mineral-surfaced roll roofing is not generally recommended though it has been used successfully to extend the life of a roof when reroofing was not justified.

## Section V. MAINTENANCE METHODS—ASPHALT ROLL ROOFING

### 6.5.1 Recoating Smooth-Surfaced Roll Roofings

Smooth surfaced roll roofing that has been exposed from 3 to 5 years will usually show one or more of the following conditions that indicate a need for recoating: Asphalt coating alligatored or cracked, small coating blisters cracked and broken and other small breaks in the coating that expose the felt; Minor hail or other impact damage, where the asphalt coating is damaged but the felt remains

intact, also indicates a need for recoating. To treat smooth-surfaced roll roofing remove all loose dust and dirt by sweeping, vacuuming or air blast. Apply clay-type asphalt emulsion or asphalt-base roof coating as described in paragraph 4.5.3.3.2 except that the coating of asphalt primer should be omitted in all but the most severely weathered roofings. For methods of making minor repairs before the recoating operation, see paragraphs 6.6.1 through 6.6.4.2.

## 6.5.2 Recoating Mineral-Surfaced Roll Roofings

Because of the protection afforded by the mineral-surfacing granules, mineral-surfaced roll roofing weathers much more slowly than the smooth-surfaced type, and, consequently, requires less maintenance. As with asphalt-shingle roofing, by the time deterioration through loss of granules becomes serious, the condition of the roofing will be normally such, through brittleness and general

deterioration, that recoating will not be desirable. However, in cases where the future use of a building is in doubt, mineral-surfaced roofs may be recoated as described for smooth-surfaced roofs. Mineral-surfaced roll roofing that has been in place not more than half the period it is expected to serve, but has been damaged by hail, should be recoated if the damage consists of loss of mineral surfacing without breaks in the felt.

## Section VI. REPAIR METHODS—ASPHALT ROLL ROOFINGS

Since repair methods for smooth- and mineral-surfaced roll roofings are identical, they are treated together in this section.

### 6.6.1 Small Breaks

Nail holes and small breaks caused by hail or other mechanical damage, if limited in number, should be repaired by applying asphalt plastic cement that meets with Federal Specification SS-C-153, Type I, Class A — summer grade or Class B — winter grade.

### 6.6.2 Large Breaks

Large breaks are repaired as illustrated in figure 35,

by opening the horizontal seam below the break and inserting through it a strip of roofing of the type used originally. Extend the strip at least 6 inches beyond the edges of the break, with the lower edge flush with the horizontal exposed edge of the covering sheet. Coat the strip liberally with lap cement where it will come in contact with the covering sheet before inserting it. After inserting the strip, press down the edges of the roofing firmly and nail securely with the nails about  $\frac{3}{4}$  inch from the edges and spaced approximately 2 inches. Apply lap cement to the horizontal seam, press down firmly and re-nail if the original seam was nailed.

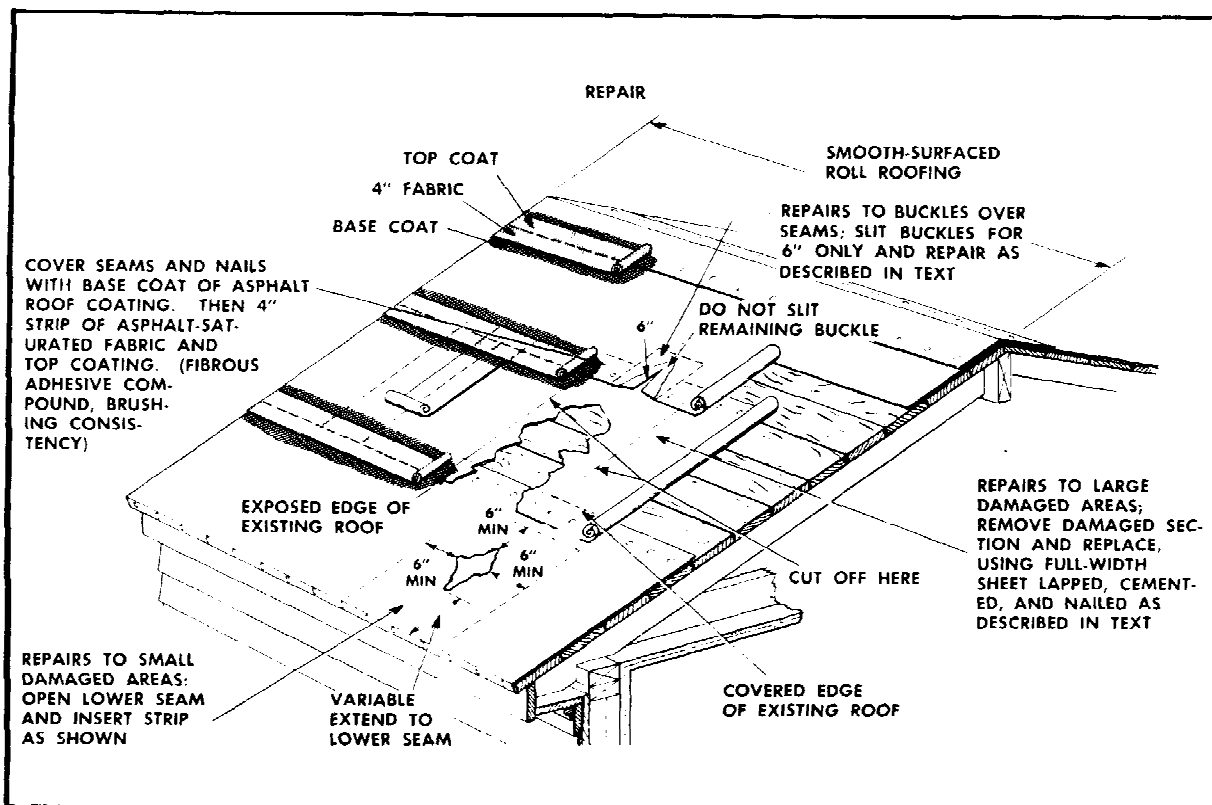

Figure 35. Repairing asphalt roll roofing.

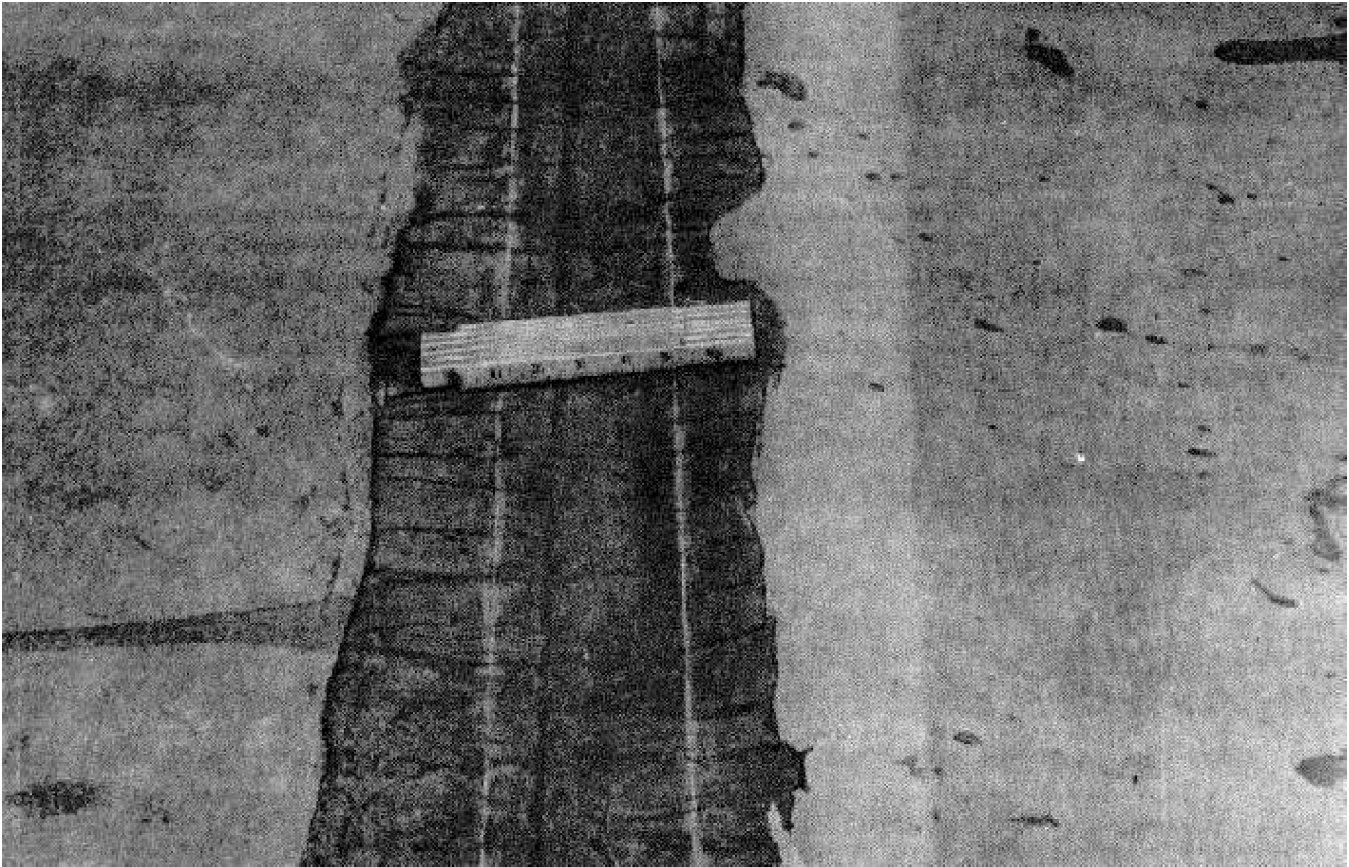

Figure 36. Closeup view — repaired roll roofing seam.

### 6.6.3 Large Areas

Where a considerable area has been damaged, but the main area of the roof remains intact, remove the roofing from the damaged area and apply new roofing of the same type, using full-width sheets applied in the same manner as the original roofing.

### 6.6.4 Repairing Leaky Seams of Roll Roofing

Other necessary repairs should be made prior to repairing the seams by two methods below. Leaks occur most frequently at the seams of roll roofing, caused by inadequate lapping, nailing or cementing, loose nails, and fishmouths.

*6.6.4.1 For an Expected use of not More Than 1 Year.* Sweep the seams to remove accumulated dust and dirt, cut all buckles (fishmouths) which terminate at the seams, and insert a strip of roofing as described in paragraph 6.6.2. Renail where necessary. Apply asphalt plastic cement complying with Federal Specification SS-C-153, Type I, Class A — summer grade or Class B — winter grade to the seams, using a trowel to feather the edge of the cement at the top of the strip. Approximately

6 pounds of cement are required per square of roofing.

*6.6.4.2 For an Expected use of More than 1 Year.* Permanent repairs to leaky seams of roll roofing roofs are best effected by using a membrane such as asphalt saturated woven cotton fabric (ASTM Specification D173), woven glass fabric (Federal Specification SS-R-620), or light weight, smooth-surfaced roll roofing (ASTM Specification D224), cemented over the seam and coated with a bituminous compound conforming to Federal Specification SS-A-694 (fig. 36). Apply the coating to the seams in strips approximately 6 inches wide using approximately one gallon per 80 lineal feet of seam. Embed a 4-inch strip of saturated fabric in the coating, pressing it firmly into the coating until it lies flat without wrinkles or buckles; the center of the fabric must be directly over the exposed edge of the roofing. Then apply another coat of coating directly over the strip of saturated fabric so the fabric is completely covered and the first and second coatings are continuous. The seams must be maintained by recoating with the same material every 2 or 3 years.

## Section VII. REROOFING WITH ROLL ROOFING

Preparation of the roof deck for reroofing with roll roofings when the existing roofing is removed or over existing roll roofing, asphalt-shingle, or wood-shingle roofs is identical with that described for reroofing with asphalt shingles. See chapter 5, section VI, entitled "Re-roofing With Asphalt Shingles." Roll roofings should be applied in accordance with current specifications for new construction except that, when applying roll roofings over existing asphalt-shingle, roll roofing

or wood-shingle roofs, 1 $\frac{3}{4}$  inch nails should be used. Roll roofing should be cut into 12 to 18 foot lengths and laid out on a flat surface to lose its "roll" prior to application. Detailed information on the application of roll roofings is available in the publication entitled "Manufacture, Selection and Application of Asphalt Roofing and Siding Products," published by the Asphalt Roofing Manufacturing Association, 757 Third Avenue, New York, New York 10007.



## CHAPTER 7

# ASBESTOS-CEMENT ROOFING

---

### Section I. DESCRIPTION AND GENERAL DISCUSSION

#### 7.1.1 General

Asbestos-cement roofing is composed mainly of portland cement and asbestos fibers. The mixture is formed, while wet, under pressure and is then cured, usually by steam. Since it is composed entirely of inorganic materials, asbestos-cement roofing is extremely resistant to normal weathering. It is quite brittle initially and becomes more brittle on long exposure. Hence, foot traffic on asbestos-cement roofing must be strictly limited, particularly on shingles. For information on the application of asbestos-cement shingles, it is suggested that the following publication be obtained: "Mineral Fiber Roof Shingles Application Manual," published by the Mineral Fiber Products Bureau, 509 Madison Avenue, New York, N.Y. 10022.

#### 7.1.2 Types

*7.1.2.1 General.* Basically, asbestos-cement roofing consists of four major types of shingles and the corrugated sheets. The American method shingles (individual shingles) are  $\frac{1}{4}$  inch thick and should not be applied on slopes of less than 4 inches per foot. Multiple-unit shingles and shingles laid by the dutch-lap and hexagonal methods are  $\frac{5}{32}$  inch thick and should not be applied on slopes lower than 5 inches per foot. Corrugated sheets should not be applied on slopes of less than 3 inches per foot.

*7.1.2.2 American Method Shingles.* American method shingles are so-called because of their shape and finish. Laid in a rectangular pattern and having a simulated wood grain surface, they produce an appearance similar to wood shingles. Their butt thickness results in deep shadow lines. They are, as other types of shingles, packaged and sold by the square. In size, number per square, and weight per square, they vary slightly among different manufacturers; however, they are generally  $\frac{1}{4}$  inch thick and provide greater weight and better coverage than any of the other types. This type shingle is also produced with surface, color, and edges similar to slate.

*7.1.2.3 Dutch Lap Shingles.* Dutch lap shingles, sometimes called Scotch lap, are larger than conventional shingles and are lapped at one side. This method of application can effect savings in both material and labor. They are 16 inches by 16 inches in size and are manufactured with a simulated texture. Always head-lapped 3 inches, they can be applied either with a  $\frac{1}{4}$  or a  $\frac{1}{3}$  side-lap. With a  $\frac{1}{4}$  side-lap the exposed area is 13 inches by 12 inches. A square (92 shingles) weighs approximately 265 pounds. A  $\frac{1}{3}$  side-lap leaves an exposed area of 13 inches by  $10\frac{2}{3}$  inches. This type shingle is also available in the 12 inches by 24 inches Ranch Design.

*7.1.2.4 Hexagonal Shingles.* The hexagonal type shingle, also known as the French method, is nearly square and has a smooth finish. They are 16 inches by 16 inches and are applied in a diamond pattern, thus creating a hexagonal or honeycomb appearance. A square (88 shingles) weighs approximately 240 pounds.

*7.1.2.5 Multiple-Unit Shingles.* Multiple unit shingles are produced in large units, each of which covers an area equal to that of 2 to 5 standard-sized shingles. Different manufacturers make various styles and sizes, but when installed they all retain the general appearance of American method shingles applied individually. The five-sided triangular top shingle, which is one of the most popular, for example, is 14 inches by 30 inches with a weather exposure of 6 inches by 30 inches when applied. A square (80 shingles) weighs approximately 325 pounds.

*7.1.2.6 Corrugated Sheets.* Corrugated asbestos-cement roofing is furnished in sheets 42 inches wide and 1 to 12 feet long in increments of 6 inches. Each sheet has 10 corrugations having 4.2 inch pitch and  $1\frac{1}{2}$  inch depth. The corrugations are thicker at ridges and valleys than at sides but average about  $\frac{3}{8}$  inch thick. Roofing may weigh slightly over 500 pounds per square applied, and is used principally on industrial buildings. All roofing laps should be laid in a continuous bead of cement as recommended by the manufacturers. Sheets are

normally laid with a side lap of one corrugation and an end lap of not less than 6 inches. In localities where driving rain or snow occur or if roof slope is less than 4 inches per foot, side and laps should be increased.

### **7.1.3 Fire Resistance Rating**

Asbestos-cement shingles that provide two or more thicknesses (American method) over a layer of 15-

pound asphalt-saturated asbestos felt are eligible for the class A fire-resistance rating of the Underwriters' Laboratories, Inc., which indicates that they are effective against severe fire exposure. Single-coverage shingles (Dutch lap or hexagonal methods) over 15-pound asphalt-saturated asbestos felt are eligible for the class B rating, indicating effectiveness against moderate fire exposure.

## **Section II. ROOF DECKS FOR ASBESTOS-CEMENT ROOFS**

### **7.2.1 Asbestos-Cement Shingles**

Wood decks for asbestos-cement shingle roofs should be of well-seasoned sheathing lumber, not less than 1 inch in thickness, not more than 6 inches wide and, preferably, tongued and grooved. The roof deck should be kept dry at all times. Sheathing boards should be fastened to each rafter with two nails to provide a smooth, even surface. Plywood with exterior glue may also be used for sheathing. A rigid roof frame is required because of the tendency of asbestos-cement roofing to crack at the fasteners when small movements occur. The deck

should be covered with 15-pound asphalt-saturated felt prior to laying the shingles. Tar-saturated felt should not be used. This underlayment is necessary to guard against the infiltration of wind and rain. In addition, it provides a cushion for the asbestos-cement shingles.

### **7.2.2 Corrugated Asbestos-Cement Sheets**

Corrugated asbestos-cement sheets are normally laid over open wood or steel framing.

## **Section III. STORAGE AND HANDLING OF ASBESTOS-CEMENT ROOFING**

### **7.3.1 Asbestos-Cement Shingles**

Asbestos-cement shingles should be kept dry at all times. Exposure to moisture during transportation or storage may cause discoloration of the shingles. Shingles should be stacked on edge, preferably on planks at least 4 inches from the ground, if stored outdoors. Piles of shingles should be not more than 4 feet high. Asbestos-cement shingles should be handled carefully to avoid breakage. If bundles are wired, they should not be lifted by the wires.

### **7.3.2 Corrugated Asbestos-Cement Sheets**

Asbestos-cement corrugated sheets should be stored and handled with the same care as asbestos-cement shingles. They should always be kept dry. Crated sheets should not be uncrated until needed. When uncrated they should be placed on firm, level supports, preferably on pieces 2 inches by 4 inches spaced 12 inches to 18 inches and laid at right angles to the corrugations. Sheets should not be stacked more than 4 feet high. (Some manufacturers recommend 2 feet.)

## **Section IV. DETERMINING TREATMENT FOR ASBESTOS-CEMENT ROOFS**

Investigation has shown that mechanical damage, such as from hail, traffic, limbs of trees, warping of the roof deck, etc., and failure of fasteners, constitute the principal causes of maintenance and repair work on asbestos-cement roofs. If only a few shingles or corrugated sheets are broken, they should be removed and new ones applied. If a large percentage (25 percent or more) are broken, they should all be removed and a new roof applied. The age and condition of undamaged units should determine whether those salvaged from the old roof

should be reused with new units. When an asbestos-cement roof fails because of failure of the fasteners, the failure is usually a general one and piecemeal repair is futile. When such failure occurs, normally on a very old roof, it is best to remove the entire roof. Whether the old roofing should be reapplied must be determined by its age and condition. No sharp distinction can be drawn between maintenance and repair work in asbestos-cement roofing. Maintenance and repair methods are therefore treated under one heading.

## Section V. MAINTENANCE AND REPAIR METHODS—ASBESTOS-CEMENT ROOFING

### 7.5.1 Asbestos-Cement Shingles

*7.5.1.1 Removing Broken Shingles and Applying New Ones.*

*7.5.1.1.1 Shingles Applied by the American Method.* Follow the method described and illustrated in chapter 8, for replacing a broken slate with a new one. The same procedures can be followed with multiple-unit shingles.

*7.5.1.1.2 Shingles Applied by the Hexagonal Method.* Straighten the anchors, shatter the shingle and remove the broken pieces. Use the nail ripper to cut or draw the nail. Punch a hole in a small piece of copper, galvanized iron, or painted tin, place over a bottom anchor and nail firmly to the roof deck. Notch a new shingle to pass side anchors. Slide the new shingle into place over the bottom anchor and bend down to hold it in place.

*7.5.1.1.3 Shingles Applied by the Dutch-Lap*

*Method.* Shear off nails and storm anchors with a ripper and remove the broken shingle. Loosen nail in exposed shingle and insert a new anchor. Drive loosened nail home. Apply two spots of roofing cement to the underlying shingle and insert new shingle engaging the storm anchors. Embed the new shingle in the spots of roofing cement and clinch anchors.

### 7.5.2 Asbestos-Cement Corrugated Sheets

Broken asbestos-cement corrugated sheets should be replaced with new ones fastened in the same manner as the original sheets. If this is not practicable, toggle bolts with lead or plastic washers may be used. These bolts pass through holes somewhat larger than the bolt and when drawn tight, the washer forms a waterproof seal.

## Section VI. REROOFING WITH ASBESTOS-CEMENT ROOFING

### 7.6.1 Asbestos-Cement Shingles

*7.6.1.1 Preparing Deck for Reroofing.* For instructions for preparing the roof deck for reroofing with asbestos-cement shingles when the existing roofing is removed and when asbestos-cement shingles are to be applied over an existing asphalt-shingle or roll-roofing roof, refer to paragraph 5.6, "Reroofing with Asphalt Shingles." While it is entirely possible to apply asbestos-cement shingles over the roofings mentioned, the long service that is normally expected of asbestos-cement shingles indicates that the better practice is to remove the existing roofing, make the repairs to the deck necessary to bring it to as nearly "new" condition as practicable, and cover the deck with a 15-pound asphalt-saturated felt, laid horizontally, with a 2-inch headlap. End laps should be a minimum of 4 inches. Nail the felt with sufficient large-headed roofing nails to hold it in place during application of shingles.

*7.6.1.2 Applying Asbestos-Cement Shingle Roof.* Space limitations do not permit inclusion of instructions for applying all types of asbestos-cement shingles. Step-by-step directions for installing multiple-unit shingles are described below. Essentially this same method is used for American method shingles. Detailed instructions for applying other types can be obtained from their manufacturers.

*7.6.1.2.1 Starter Course.* Lift up the edge of underlayment at the eaves and lay a full-size starter shingle. Let it over-hang the eaves and gable

approximately 1 inch and secure it with four galvanized nails. Apply succeeding starters, spaced  $\frac{1}{16}$  inch apart, in the same manner until entire course is laid.

*7.6.1.2.2 First and Succeeding Courses.* The first course of the main roof is laid directly over the starter course starting with a half shingle with the vertical edge projecting 1 inch beyond the gable and butt edge projecting 1 inch beyond the eaves. Fasten each shingle with four galvanized nails. Do not drive nails "home" as in laying wood shingles. Lay the second course with a full-size shingle so that the shoulder coincides with the point of the underlying course. A 6-inch exposure is automatically obtained. Start the succeeding course with a half-size shingle, then a full-size shingle, alternating with each course.

*7.6.1.2.3 Hip and Ridge Finish.* Lay roof shingles so that they butt closely against furring strips placed at hips and ridges. Cover furring strips with asbestos felt and apply hip and ridge shingles. Start laying the ridge shingles on main roof at the end of the ridge farthest away from prevailing storms. When covering hips, start at the lower end. Fasten each shingle with two nails and point up with slaters cement.

*7.6.1.2.4 Nails.* Large-head, galvanized, needle-point roofing nails should be used. For new roofs,  $\frac{1}{4}$  inch nails are adequate; for application over existing roofs, 2-inch nails should be used. For application over plywood decks, nails should be barbed or threaded.

### **7.6.2 Asbestos-Cement Corrugated Sheets**

Asbestos-cement corrugated sheets should be applied in accordance with current specifications for new construction. Manufacturers of asbestos-

cement corrugated sheets maintain engineering and estimating services to assist users in determining the quantities of materials required for particular jobs. At least two manufacturers should be consulted.

## CHAPTER 8

# SLATE ROOFING

---

### Section I. DESCRIPTION AND GENERAL DISCUSSION

#### 8.1.1 Description

Slate is a natural rock which was formerly much more widely used as a roofing material than at present. Consequently, most slate roofs that are encountered are old ones, on permanent structures. Some of the oldest roofs in the country are of slate, slate roofing having been produced for more than 200 years. Slate colors are designated Black, Blue Black, Gray, Blue Gray, Purple, Mottled Purple and Green, Green (fading and unfading), and Red.

#### 8.1.2 Availability

Most roofing slate has been produced in two counties in eastern Pennsylvania, although the colored slates from western Vermont and eastern New York, and the gray (Buckingham) slates from Virginia, have also been used widely. The quarries that produced the earliest, and possibly the most enduring, slates on the Pennsylvania-Maryland border (Peach Bottom) are no longer operated for roofing slate. The eastern Pennsylvania slates are classed as "fading" slates, in that they change color on long exposure, the most common form of fading being that where the sides and bottom of the exposed portion of the slate changes to a light gray or tan, which will eventually spread over the entire exposed surface. This change may start in a

relatively short time, 10 to 12 years, with slates of poor quality. It is usually accompanied by a partial disintegration of the faded portion. However, many such roofs that have rendered from 50 to 60 years of satisfactory service are known. The New England and Virginia slates generally are nonfading (except New England fading green) and render excellent service, roofs of these slates more than 80 years old being not uncommon.

#### 8.1.3 Characteristics

Roofing slate is quite brittle and becomes more brittle on exposure. It is produced in a variety of sizes and is usually laid by the American method. Roofing slate is normally 3/16-inch thick, but on monumental jobs, may range in thickness from 3/16 to 2-inches for architectural effect. Slate roofs may vary in weight per square from 650 to 8000 pounds, depending upon the thickness.

#### 8.1.4 Fire Classification

Roofing slate is not classified as to fire resistance by the Underwriter's Laboratories, Inc., but a reasonable classification would be one similar to that for asbestos-cement shingles, since they are fireproof.

### Section II. ROOF DECKS FOR SLATE ROOFS

Wood decks for slate roofs should be of well-seasoned sheathing lumber, not less than 1 inch in thickness, not more than 6 inches wide, and, preferably, tongued and grooved. Specifications formerly suggested 8 or 10 inch widths, but the narrower boards cause less breakage.

Sheathing boards should be fastened to each rafter with two nails to provide a smooth, even surface. Roof decking may also be plywood with exterior glue. The deck should be covered with 30-pound asphalt-saturated felt prior to laying the slates. The roof deck should be kept dry at all times.

### Section III. STORAGE AND HANDLING OF SLATES

Roofing slates should be handled carefully to avoid breakage. They should be stacked on edge, preferably on planks, to give a firm, level support. Tiers of slate should be separated by wooden lath

placed 1 inch from the outside edges of the slates. Slates should normally not be stored more than 6 tiers high. When stored outdoors, they should be covered, particularly in freezing weather.

### Section IV. DETERMINING TREATMENT OF SLATE ROOFS

#### 8.4.1 General

As with asbestos-cement roofing, mechanical damage, such as that from hail, traffic, limbs of trees, warping of the roof deck, etc., and failures of fasteners, constitute the principal causes of maintenance and repair work on slate roofs. Actual failure of the slate due to weathering will occur eventually. With slate of poor quality, this may happen in less than 25 years. With slate of good quality it may be after more than 100 years of exposure and usually after the slates have been relaid because of the failure of the original fasteners.

#### 8.4.2 Replacement or Reuse

If only a few slates are broken, they should be removed and new ones applied. If a large percentage are broken (25 percent or more), all slates should be removed and a new roof applied. The age and condition of the undamaged slates should

determine whether those salvaged from the old roof should be reused.

*8.4.2.1 Criteria.* No definite criteria can be given for determining whether a slate should be reused. However, if the part that has been exposed is not faded appreciably and shows no disintegration; and if the slate gives a sound "ring" when it is held between thumb and finger by one corner as lightly as possible and struck a sharp blow by the knuckles, it may be safely reused.

*8.4.2.2 Fastener Failure.* When the failure of a slate roof is due to failure of the fasteners, the failure is usually a general one, and, as with asbestos-cement roofing, piecemeal repair is futile, and it is best to remove the whole roof. Whether the old slate should be reapplied must be determined by its age and condition. A case is known where slate applied originally about 1870 was removed because of failure of the nails and successfully reapplied during World War II.

### Section V. MAINTENANCE AND REPAIR METHODS—SLATE ROOFS

#### 8.5.1 General

No sharp distinction can be drawn between maintenance and repair work in slate roofing. Maintenance and repair methods are therefore treated under one heading.

#### 8.5.2 Replacing Broken Slate

In replacing a broken slate, remove the broken slate and cut the nails with a ripper. Insert a new slate of the same color and size as the broken one and nail

it through the vertical joint of the next course above, driving the nail about 2 inches below the butt of the slate in the second course above. Force a 3- by 6-inch or larger strip of copper under the course above the nail and bend the strip slightly concave to hold it in place. The strip should extend about 2 inches under the second course above and cover the nail and extend 2 inches below it (fig. 37).

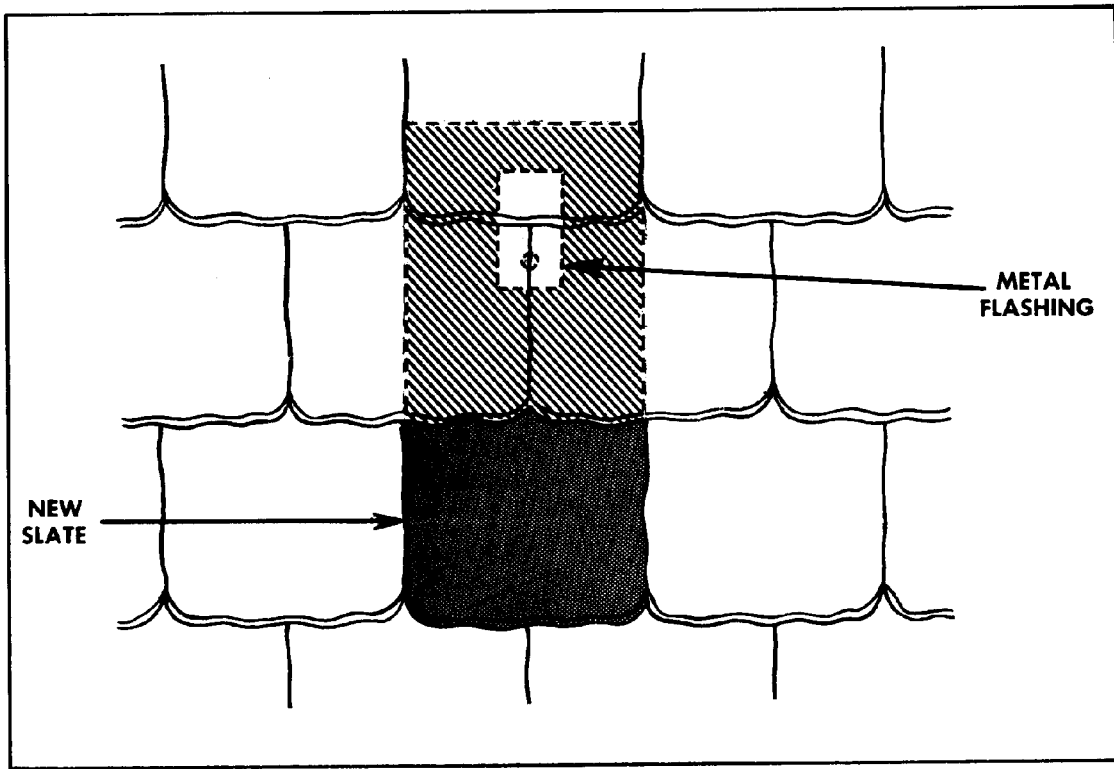

Figure 37. Method of inserting new slate.

## SECTION VI. REROOFING WITH SLATE

### 8.6.1 Preparing Deck for Reroofing

For instructions for preparing the roof deck for reroofing with slate when the existing roofing is removed, refer to paragraph 5.6.2.1 above. When slate is used to replace a lighter material, the roof framing should be checked to determine whether it has adequate strength. As with asbestos-cement shingles, the long service that is normally expected from a slate roof indicates that the better practice is to remove the existing roofing, make the repairs to the roof deck to as nearly "new" condition as practicable and cover with a 30-pound asphalt-saturated felt laid horizontally with a 4-inch head-lap and 6-inch end laps. Secure the felt with large-headed roofing nails as necessary to hold it in place until covered by slate.

### 8.6.2 Applying Slate Roof

**8.6.2.1 Starter Course.** Apply a cant strip of suitable thickness, depending upon the thickness of the slate, at the eaves. Lay the starter course over the cant projecting 2 inches at the eaves and 1 inch at the gable. Fasten each slate with two large-headed slating nails. Drive the nails so that their heads just touch the slate. Do not drive the nails "home." The length of the starter course may be

found by adding 3 inches to the exposure being used on the regular slate, while the thickness depends upon the thickness of the slate.

**8.6.2.2 First and Succeeding Courses.** Apply the first course of slate over the starter course with the butts of both courses flush and the joints broken. Fasten each slate with a minimum of 2 large-headed slating nails. Apply the second and succeeding courses with a headlap of 3 inches and joints broken. Bed all slates on each side of hips and ridges within 1 foot of the top and along rakes within 1 foot of the edge in approved elastic cement and cover all exposed nail heads with elastic cement. Lay slate roofs with open valleys. Only the most durable and permanent nonferrous metals should be used for all flashings for slate roofs.

**8.6.2.3 Nails.** Nails for slating should be of nonferrous metal and of proper size. Large-headed copper slating nails are satisfactory. For commercial standard slates, 18 inches or less in length, use 1¼-inch nails; for longer slates, 1½-inch nails should be used. A good rule to use in determining the proper size nail is to add one inch to twice the thickness of the slate. Two-inch nails should be used on hips and ridges.

# CHAPTER 9

## TILE ROOFING

---

### Section I. DESCRIPTION AND GENERAL DISCUSSION

#### 9.1.1 General

Most roofing tiles are clay or shale products that are burned to a hard, dense structure, with or without a glazed exposure surface. A few cement tiles have been produced.

#### 9.1.2 Sloping Roofs

Several types of tiles are used for sloping roofs, namely, shingle, Spanish, mission and interlocking, but in these general types there are many variants in size, form, and color. Minimum slope should be 4-inches per foot.

#### 9.1.3 Promenade Tile

The so-called promenade tiles used for surfacing

flat, built-up roofs that are subjected to traffic are usually square-edged shale tile not less than  $\frac{3}{4}$  inches thick.

#### 9.1.4 Weights

Tile roofs are extremely heavy, ranging in weight from 800 to 1800 pounds per square; consequently, they require very strong framing to support them.

#### 9.1.5 Fire Classification

Roofing tiles are not classified as to resistance to fire by the Underwriter's Laboratories, Inc., but since they are fireproof, they should be rated at least equal to asbestos-cement and slate roofings.

### Section II. DECKS FOR TILE ROOFS

#### 9.2.1 Sloping Decks

Wood decks for tile roofs may be of well-seasoned sheathing lumber, tongued-and grooved and not more than 6 inches wide or plywood with exterior glue. Sheathing boards should be fastened to each rafter with two nails to form a smooth, even surface. The roof deck should be covered with 30-pound asphalt-saturated felt prior to laying the tiles. Concrete decks with nailing strips and nailable concrete decks are also used.

#### 9.2.2 Flat Decks

Promenade tile on flat decks are laid over a conventional asphalt or coal-tar-pitch built-up roof, usually consisting of a coated base sheet plus three or more plies of saturated felt, with a final mopping of 25 pounds per 100 square feet of asphalt or

coal-tar pitch instead of the usual heavy pouring of bitumen specified for roofs surfaced with slag or gravel. A coal-tar-pitch built-up membrane is preferred for dead level decks. Promenade tiles should be laid in a bed of portland cement mortar (1 to 3) approximately 1 inch thick. It is good practice to separate the setting bed from the underlying built-up roofing by a drainage course of crushed stone or gravel. Joints should be  $\frac{3}{16}$  to  $\frac{1}{4}$  inch wide, filled flush with portland cement mortar (1 to 2). Expansion joints,  $\frac{3}{4}$  inches wide, filled with a waterproofing calking compound, should be provided on 10-foot centers and at skylights, curbs and walls. Expansion joints should extend from the top of the tile through the cement mortar to the top of the drainage bed. Finished surfaces should be sloped for drainage.

### Section III. STORAGE AND HANDLING OF TILES

Store and handle roofing tiles as described in

section III, chapter 8, "Storage and Handling of Slates."



## Section IV. DETERMINING TREATMENT FOR TILE ROOFS

### 9.4.1 Sloping Roofs

Mechanical damage, such as that from hail, traffic, tree limbs, etc., and failure of fasteners constitute the principal causes of maintenance and repair work on tile roofs. The principles that determine the treatment for sloping tile roofs are essentially the same as those for determining the treatment of slate roofs, except that occasionally, after very long period of service, tile roofs that are in otherwise satisfactory condition may leak because of the disintegration of the felt underlayment.

### 9.4.2 Flat Roofs With promenade Tile

The most frequent cause of maintenance or repair work on a promenade tile roof is that necessitated by too few expansion joints between the promenade tile or by permitting the expansion joints to become filled with nonresilient material. Leaks through promenade decks are likely to be the result of a break in the waterproof membrane of flashing. If a deck is leaking, it is necessary to remove sufficient tile and setting bed to find the break in the membrane and repair it. Maintenance and repair methods for the built-up roof membrane are discussed under Built-up Roofing.

## SECTION V. MAINTENANCE AND REPAIR METHODS—TILE ROOFS

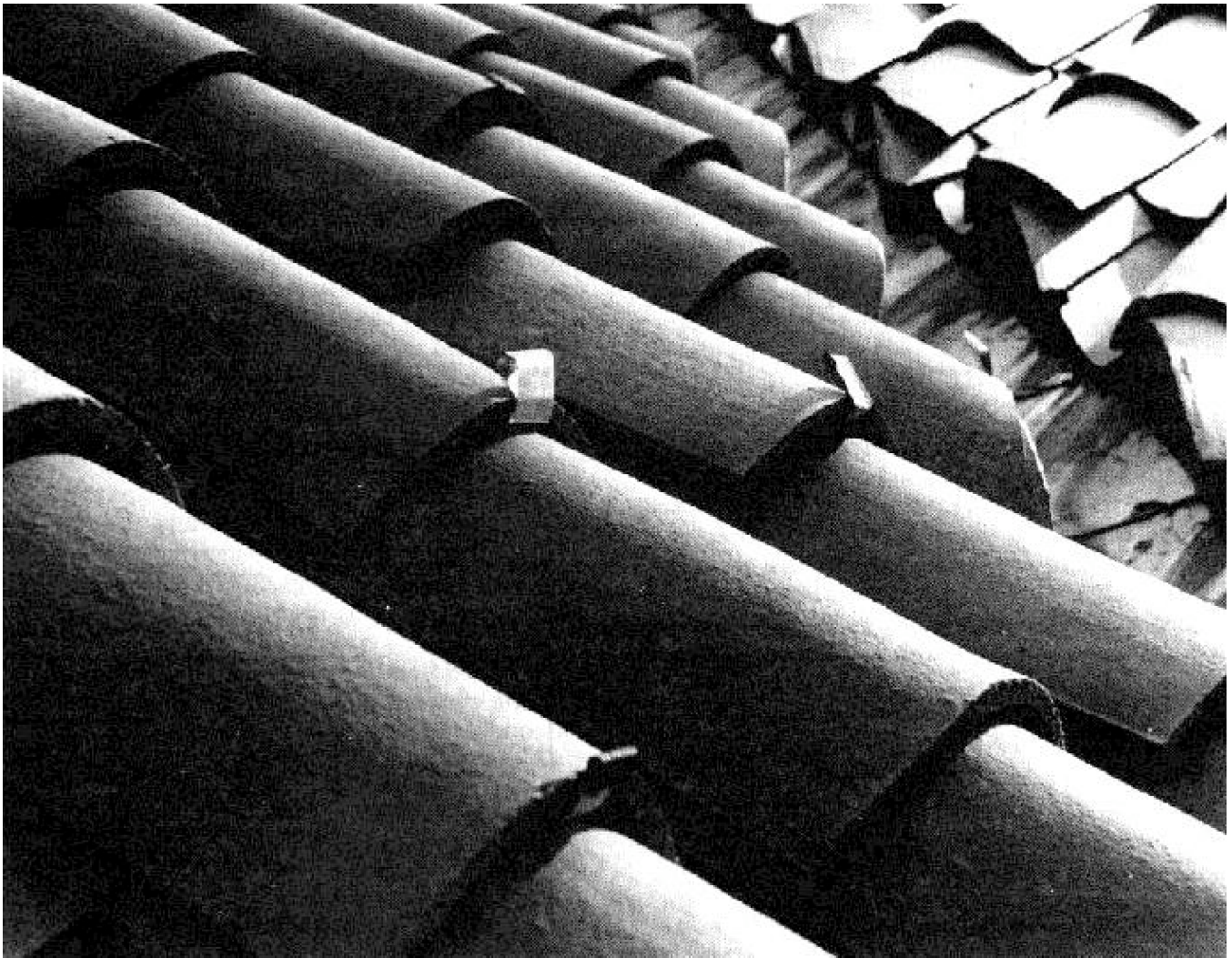

*Figure 38. Replaced tiles fastened in place with metal strips.*

Maintenance and repair methods for tile roofs are treated under one heading since no clear-cut distinction can be made between them.

### 9.5.1 Sloping Roofs

Replace broken shingle tiles with new ones by the method described for replacing broken slates, section V, chapter 8. Replace broken Spanish or mission tiles by troweling portland cement mortar on the new tile surface that will be lapped by the tile in the course above and on the surface that will lap the tile in the course below. Fasten the new tile in place with a metal strap or wire (fig. 38). Interlocking tiles use special fastenings and are replaced easily. It is sometimes impossible to match the exact shape or color of very old tiles. When a

number of buildings are roofed with the same kind of old tiles, it may be necessary to reroof the first with new tiles that match the old as nearly as possible, keeping sound tiles salvaged from the first roof to patch the other roofs and to replace tiles broken when the other roofs need to be reroofed.

### 9.5.2 Promenade Tile on Flat Decks

When insufficient expansion joints cause raising of the promenade tile, new joints should be installed. Expansion joints of 10-foot centers and at skylights, curbs, and walls are considered adequate. If expansion joints have become filled with nonresilient material or if the expansion joint material has deteriorated, it should be raked out and new material installed.

## Section VI. REROOFING SLOPING ROOFS WITH TILE

### 9.6.1 Preparing Deck

Existing roofing should be removed and the roof deck restored to as nearly "new" condition as practicable by removing rotted or warped sheathing boards and replacing them with new ones, and applying a 30-pound asphalt-saturated felt horizontally, with a 4-inch headlap and a 6-inch side lap. Secure the felts along laps and exposed sheets with large-headed roofing nails as necessary to hold it in place until the tile is laid.

### 9.6.2 Applying Tile Roof

*9.6.2.1 Mission and Spanish Tiles.* Nailing strips for mission and spanish tile should be pressure treated with wood preservative. Lay tiles with open valleys. Set eaves closures back 2 inches from the lower edge of eave. Lay pan tiles with uniform exposures to the weather. Lay cover tiles in a uniform pattern, except where otherwise necessary to match existing roofs. Give all tiles a minimum lap of 3 inches and extend pan tiles 1 inch over rear edge of gutter. Cut tiles to meet projections with finished joints and point up with roofer's cement. Waterproof the spaces between

field tiles and wood nailing strips at ridges and hips with a fill of roofer's cement. Fit all tiles properly and then secure them with nails long enough to penetrate at least 1 inch into the wood base. Match the tile courses on dormer roofs with those on the main roof. Where winds of hurricane intensity can be expected, consideration should be given to reinforcing tile roofs by laying all field tiles in portland cement mortar. To do this, fill the ends of tiles at eaves, hips, ridges, solid with cement mortar and fill the full width of laps between the tiles, both parallel and perpendicular to the eaves, with cement mortar.

*9.6.2.2 Slab Shingle Tiles.* Lay slab shingle tiles with a 2-inch headlap and secure each tile with two large-head roofing nails. Double the tiles at the eaves and project them 1 inch over the rear edge of gutters. Lay all tiles within 1 foot of hips, ridges, and abutting vertical surfaces in roofer's cement. Lay 10 or 12 inch tiles with 1 inch headlap on sides of dormers. Match the tile courses on dormer roofs with those on the main roof. Lay tile roofs with open valleys.

## CHAPTER 10

### WOOD-SHINGLE ROOFING

---

#### Section I. DESCRIPTION AND GENERAL DISCUSSION

##### 10.1.1 General

Wood shingles are sawed. Wood shakes are split. Shingles have relatively smooth sides whereas shakes have at least one natural grain split surface. This chapter deals only with shingles since this type is most commonly used.

##### 10.1.2 Description

Wood-shingle roofs are usually of red cedar, cypress or redwood shingles. Wood shingles are available in three "Grades"; however, the description that follows applies only to the No.1 Grade. Only heartwood should be used in making wood shingles, cut so that the annual or growth rings form an angle no greater than 45° from the perpendicular when a shingle is laid flat. This defines "edge-grain" shingles and distinguishes them from flat-grain shingles which are less resistant to splitting and warping than the edge-grain shingles. Thickness is the most important dimension of wood shingles. It is measured at the butt ends and is designated according to the number of pieces that are necessary to constitute a specific unit of thickness. Thus, 5/2 indicates that the butts of five shingles measured together will give a total thickness of 2 inches. Wood shingles should be not less than 16 inches long. Maximum width is 14 inches; minimum width of shingles less than 24 inches long is 3 inches and for those 24 inches long and longer, it is 4 inches. Wood shingles are sold in bundles, with shingles packed flat in courses, the butts of shingles in alternate courses facing in opposite directions, giving a "square pack." The number of courses at each end

of a bundle are indicated so that a bundle designated 13/14 means one with 13 courses at one end and 14 at the other. Each course of shingles in a bundle averages 18½"running inches," that is, the actual width of the shingles in a course in a bundle. Given this information and the desired exposure, it is easy to calculate the number of bundles of shingles that will be required to cover a square of roof surface.

##### 10.1.3 Preservative Treatment

The treatment of wood shingles with creosote preservative materially lengthens the life of a wood-shingle roof. The creosote tends to exclude moisture; to prevent warping and splitting of the shingles; to retard rot or decay and to decrease surface weathering. In addition, shingle nails last longer with shingles that have been given a creosote treatment. Several manufacturers produce wood shingles which are pressure-treated with fire-retardant chemicals to meet Underwriters Laboratories, Inc. Class C requirements.

##### 10.1.4 Specification

Commercial Standard 31-52, Wood shingles (Red Cedar, Tidewater Red Cypress, California Redwood) available from Clearing House for Federal Scientific and Technical Information, US Department of Commerce, NBS Institute of Applied Technology, Springfield, Virginia 22151, discusses general and detail requirements for No.1 Grade wood shingles and gives a glossary of terms used in connection with wood shingles.

#### Section II. ROOF DECKS FOR WOOD-SHINGLE ROOFS

Roof decks for wood-shingle roofs may be of solid or open sheathing. Solid decks of well-seasoned sheathing lumber should be, nominal 1 inch in thickness, either tongued-and-grooved or with straight sides, or of plywood with exterior glue, not less than ½ inch thick. When open or spaced, sheathing is used, the sheathing boards (1 by 3, 1 by 4, or 1 by 6 inches) are spaced the same distance as

the anticipated shingle exposure and each course of shingles is nailed to a separate sheathing board; or 1 by 6 inch boards are spaced twice the distance of the anticipated shingle exposure. By the latter method, two courses of shingles are nailed to each sheathing board. No underlay material is required for wood shingles.

### Section III. STORAGE AND HANDLING OF WOOD SHINGLES

Wood shingles should preferably be stored under cover to maintain a uniform moisture content. If outdoor storage is necessary, bundles should be

piled on planks to prevent contact with the ground and they should be covered to protect them from the weather.

### Section IV. DETERMINING TREATMENT FOR WOOD-SHINGLE ROOFS

Wood-shingle roofs of good quality shingles applied correctly normally render long and satisfactory service. Failures in wood-shingle roofs usually occur because of warping or splitting of the shingles, decay, normal weathering, or failure of the shingle nails. Warping and splitting are found most frequently with flat-grain shingles. They occur usually on the portion of the shingle that is exposed to the weather. Neither warping or splitting is likely to affect the waterproofness of the roof because a wood-shingle roof should have three layers of shingles throughout. Splits in shingles, however, may shorten the life of a roof by permitting water to reach the nails in the shingles underneath and hasten their deterioration. Decay in wood is caused by minute organisms that thrive best in moist wood. Therefore, it is found most frequently in low-

pitched and shaded roofs that remain moist for long periods. Normal weathering proceeds slowly in wood shingles. Factors in normal weathering are wind-driven rain, snow, hail or sand and alternate freezing and thawing in winter. Very old wood-shingle roofs usually shown the exposed shingle butt just below the area protected by the overlaying shingle much thinner than the protected area. Failure of shingle nails is most frequently caused by the splitting of shingles or the improper placement of nails. The effects of all of the deteriorating factors mentioned are lessened appreciably by impregnating the shingles with creosote oil. Impregnation by dipping or by pressure process before the shingles are applied is much more effective than treatment after application.

### Section V. MAINTENANCE AND REPAIR METHODS—WOOD SHINGLE ROOFS

Maintenance and repair work for wood-shingle roofs is treated under the same heading.

#### 10.5.1 Warped Shingles

Warped shingles do not usually cause leaks and, except for appearance are not immediately objectionable. Warped shingles will probably crack eventually, in which case they should be removed. Warped shingles should never be face nailed except in preparation for reroofing. The nailing is likely to crack the shingles and the nails will work loose, permitting the roof to leak.

#### 10.5.2 Removing Cracked or Rotted Shingles and Applying New Ones

Broken wood shingles can be removed by the methods described for removing broken slates (para 8.5) except that at least four nails must be cut. After the broken shingle is removed, insert a new one of the same size and nail it through the exposed butt, preferably with thin copper nails.

Also nail the shingle immediately above through the exposed butt.

#### 10.5.3 Treating Shingles With Creosote or Shingle Stain

Creosote, Technical, Wood Preservative, (for) Brush, Spray or Open-Tank Treatment, under Federal Specification TT-C-655, is an excellent preservative for wood shingle roofs. Application by brush, while more laborious, is likely to be more effective than application by spray because of better penetration. If a colored roof is desired, pigmented stains containing creosote oil or its derivatives should be used in preference to those without creosote. The frequency of treatment varies with the kind of wood, pitch of the roof and any pretreatment the shingles may have been given prior to application. Drying-oil paints should not be used on wood-shingle roofs because unequal absorption and subsequent drying of the paint may cause the shingles to warp and curl.

## Section VI. REROOFING WITH WOOD SHINGLES

### 10.6.1 General

Wood shingles may be used for reroofing over wood and asphalt-shingle roofs and over smooth-and-surfaced asphalt roofing. However, as with other materials, the better practice is to remove the existing roof covering. Reroofing of wood-shingle roofs is usually required when:

- a. Evidence of leaks show in more than a single localized area after the roof has been exposed to no more than the usual local rainfall.
- b. It has been determined that the leaks result from shingle failure, and not from defective flashings. By reroofing only one exposure, roof failure may sometimes be corrected. Because of difficulties in nailing, no attempt should be made to apply wood shingles over metal, slate or asbestos-cement roofs.

### 10.6.2 Preparing Deck for Reroofing With Wood Shingles

*10.6.2.1 When Existing Roofing is Removed.* Proceed as described in paragraph 5.6.2.1.

*10.6.2.2 When Existing Roofing Remains.*

*10.6.2.2.1 Reroofing Over Wood Shingles.* Remove all loose and protruding nails. Replace decayed or missing shingles with new ones. Nail down or cut off corners of curled and warped shingles and re-nail loose shingles. Cut back shingles at eaves and rakes far enough to apply 1- by 4-inch strips securely nailed. Remove weathered shingles at the ridge and replace them with a strip of beveled siding, thin edge down, to provide a solid base for nailing the ridge shingles. Treat hips the same as ridges. Fill open valleys with wooden strips level with the shingle surface. Install new non-ferrous metal valley flashings. Install new non-ferrous metal base and counter flashings in accordance with new construction specifications where necessary. Sweep all loose debris from the roof deck.

*10.6.2.2.2 Reroofing Over Asphalt Roll Roofing.* Inspect carefully all sheathing boards at the eaves and replace rotted boards with new ones. Remove all loose or protruding nails. Cut all blisters and buckles and nail cut edges to the roof deck. Repaint ferrous metal flashings that are in good condition. Install new nonferrous metal base

flashings and new metal counter flashings in accordance with new construction specifications, where necessary. Install new nonferrous metal valley flashings. Sweep all loose debris from the roof.

*10.6.2.2.3 Reroofing Over Asphalt Shingles.* Proceed as described in paragraph 10.6.2.2.2, "Reroofing Over Asphalt Roll Roofing" and in addition, nail down or cut away the butts of all curled or lifted shingles.

### 10.6.3 Applying Wood Shingle Roof

Apply a double course of wood shingles at the eaves, with the butts of the shingles overhanging the eaves 1½-inches. Space all shingles in the same course ¼ inch to allow for expansion due to moisture absorption. Nail each shingle in these and subsequent courses with two nails placed 1 to 1½-inches above the butt line of the succeeding course of shingles and not more than ¾ inch from the edge of the shingle on each side. Break the joints between the shingles in successive courses at least 1½-inches and apply the shingles so that the joints in alternate courses are not in line. The exposure of wood shingles depends on the slope of the roof and on the length of the shingles. For slopes of 5 inches per foot and greater, the standard exposures are as follows:

<i>Length of shingle, inches</i>	<i>Exposure, inches</i>
16	5
18	5½
24	7½

For slopes less than 5 inches per foot, these exposures should be 3¾, 4¼, and 5¾ inches respectively. Use only hot-dipped galvanized nails, either round or square cut, for applying wood shingles. Use 1 ¼ inch nails for 16 and 18 inch shingles and 1 ½ inch nails for 24 inch shingles in new construction. When wood shingles are applied over an existing roof, use 1¾ inch nails for 16 and 18 inch shingles and 2 inch nails for 24 inch shingles. Nail heads should not be driven into the wood. Remove weathered shingles at the ridge and replace them with a strip of beveled siding, thin edge down, to provide a solid base for nailing the ridge shingles. Treat hips the same as ridges.

# CHAPTER 11

## METAL ROOFING

### Section I. DESCRIPTION AND GENERAL DISCUSSION

#### 11.1.1 General

Metal roofing and flashing materials include: copper, terne (steel coated with lead-tin alloy), zinc-coated (galvanized) steel, aluminum, stainless steel, lead, aluminum or steel (plain or stainless) with factory-applied coatings or claddings, and certain alloys. Some of the commonly used types will be discussed separately, but certain factors which apply to all kinds are discussed jointly. Considerable reference material on the design and installation of architectural sheet metal may be found in the publication "Architectural Sheet Metal Manual" published by and available from the Sheet Metal and Air Conditioning Contractors National Association, Incorporated, 1611 North Kent Street, Suite 200, Arlington, Virginia 22209. Additional information may be found in various industry publications. Tables 4 and 5 giving the properties of sheet metals and the recommended thicknesses for various uses are included at the end of this chapter.

#### 11.1.2 Expansion and Contraction

All metals used in roofing expand and contract with changes in temperature. This must be taken into account in designing metal roofs. Actually, most metal roof forms owe their design in large part to the necessity for providing for expansion and contraction. Buckling of sheets, tearing at seams, loosening or pulling through of fasteners are common failures caused by inadequate provisions for expansion and contraction. The rate of expansion and contraction differs with each metal. Some idea of the magnitude of the change for which provision must be made is given in table 2 below. Note the distance that an 8-foot sheet will expand or contract with a 150° variation in temperature. Changes in dimensions with changes in temperature result equally in all planes of the metal and are the same regardless of the thickness

of the metal. Thus, a 1-foot square piece of thin copper or aluminum foil will change as much in length and width as a thicker piece of the same size under similar temperature differences. Because of changes in dimensions with changes in temperature, metal roofs laid in summer require adequate provision for contraction, but little provision for expansion. Conversely, metal roofs laid in cold weather require adequate provision for expansion, but little provision for contraction. The expansion joint shown in figure 39 was installed midway of its expected temperature range and illustrates the position at minimum and maximum temperatures. The movement of the metal can be calculated using table 2. Metal that is exposed to the direct rays of the sun should have an additional 50° F added to its temperature to compensate for its absorption of radiant heat.

Table 2. Expansion and contraction

Metal	Coefficient of thermal expansion (inches per inch per degree F°)	Linear movement per 150° F, change per 8 feet	
		Decimal (in.)	Fraction (in— approx)
Steel Med .....	0.000067	0.0965	6/64
Iron-wrt .....	0.000067	0.0965	6/64
Nickel Copper Alloy (Monel) .....	0.000077	0.1109	7/64
Stainless Steel (300-series) .....	0.000098	0.1411	9/64
Copper .....	0.000098	0.1411	9/64
Aluminum .....	0.000128	0.1843	12/64
Lead .....	0.000162	0.2338	15/64
Zinc .....	0.000173	0.2491	16/64

#### 11.1.3 Galvanic Action

In metal roof construction it is frequently impossible to prevent the contact of dissimilar metals, which may result in corrosion of one of the metals and the protection from corrosion of the metal in contact with it. This is the so-called galvanic action or electrolysis which occurs when metals of different position in the electromotive series are in

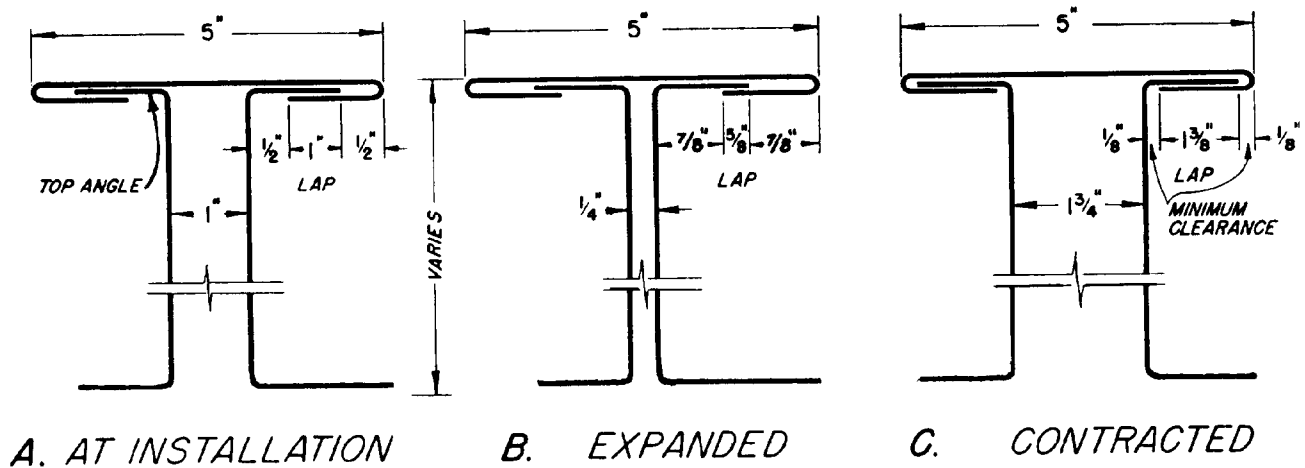

Figure 39. Movement of expansion joints.

intimate contact in the presence of an electrolyte. The metals commonly used for roofing are listed in the electromotive series in the following order:

- |             |           |
|-------------|-----------|
| 1. Aluminum | 5. Tin    |
| 2. Zinc     | 6. Lead   |
| 3. Iron     | 7. Copper |
| 4. Nickel   |           |

When any two metals in this list are in contact in the presence of an electrolyte, the one with the lower number is corroded. Also, the farther apart the metals are, the greater will be the corrosion. Thus, with iron and copper in contact in the presence of water, the iron would be corroded more than lead in contact with copper under similar conditions. Any means that separates dissimilar metals will protect against this action. Frequently used are layers of waterproof building paper or asphalt-coated felt, or a coating of asphalt paint. To the maximum extent feasible, metal roofing, siding, flashing, gutter, downspouts, and fasteners, should be of the same material.

#### 11.1.4 Workability

Workability of metals generally depends upon their hardness and ductility. The hardness regulates the equipment needed to work the metal, and the ductility governs whether the metal can withstand bending without fatigue or fracture.

#### 11.1.5 Types of Metal Roofings

Metal roofings are classified into three general types: flat sheets assembled by means of various seams, corrugated or performed sheets, and unit roofings made in the form of shingles or tiles.

**11.1.5.1 Flat Sheets.** Flat metal sheets are assembled for roofing purposes by means of various seams, commonly designated as batten seams, standing seams and flat seams.

**11.1.5.1.1 Batten-Seam Roofing.** In batten-seam roofing (fig. 40 and fig. 41), metal sheets are formed over ribs or battens, of wood or metal, which divide the roof into small areas and provide adequately for expansion and contraction in the direction perpendicular to the battens. Expansion and contraction in the direction parallel to the battens is provided best by unsoldered flat-lock cross seams. Soldered cross seams are sometimes used with the expectation that allowance for expansion and contraction is made at the eaves and ridge or that the soldered seams so stiffen the sheets that slight buckling within each sheet will occur at elevated temperatures. To the extent feasible, seams should be shop fabricated rather than formed in the field to insure accurately formed straight seams which will permit the sliding action to take place as intended. The battens must have edges beveled to permit lateral movement of the roofing. The battens must be smooth, have all nails set, and be treated to resist rot and insects.

**11.1.5.1.2 Standing-Seam Roofing.** Standing-seam roofing is similar to batten-seam roofing in that it divides the roof into relatively small areas and provides for expansion and contraction in the direction perpendicular to the seams. The roofing sheets are fastened to the roof deck by means of cleats spaced not more than 12 inches apart, nailed to the roof sheathing at one end and folded into the seam at the other. Since standing seams are unsoldered, they are used on roofs with slopes of 3 inches per foot or greater. Standing-seam roofing is illustrated in figure 40 and figure 42.

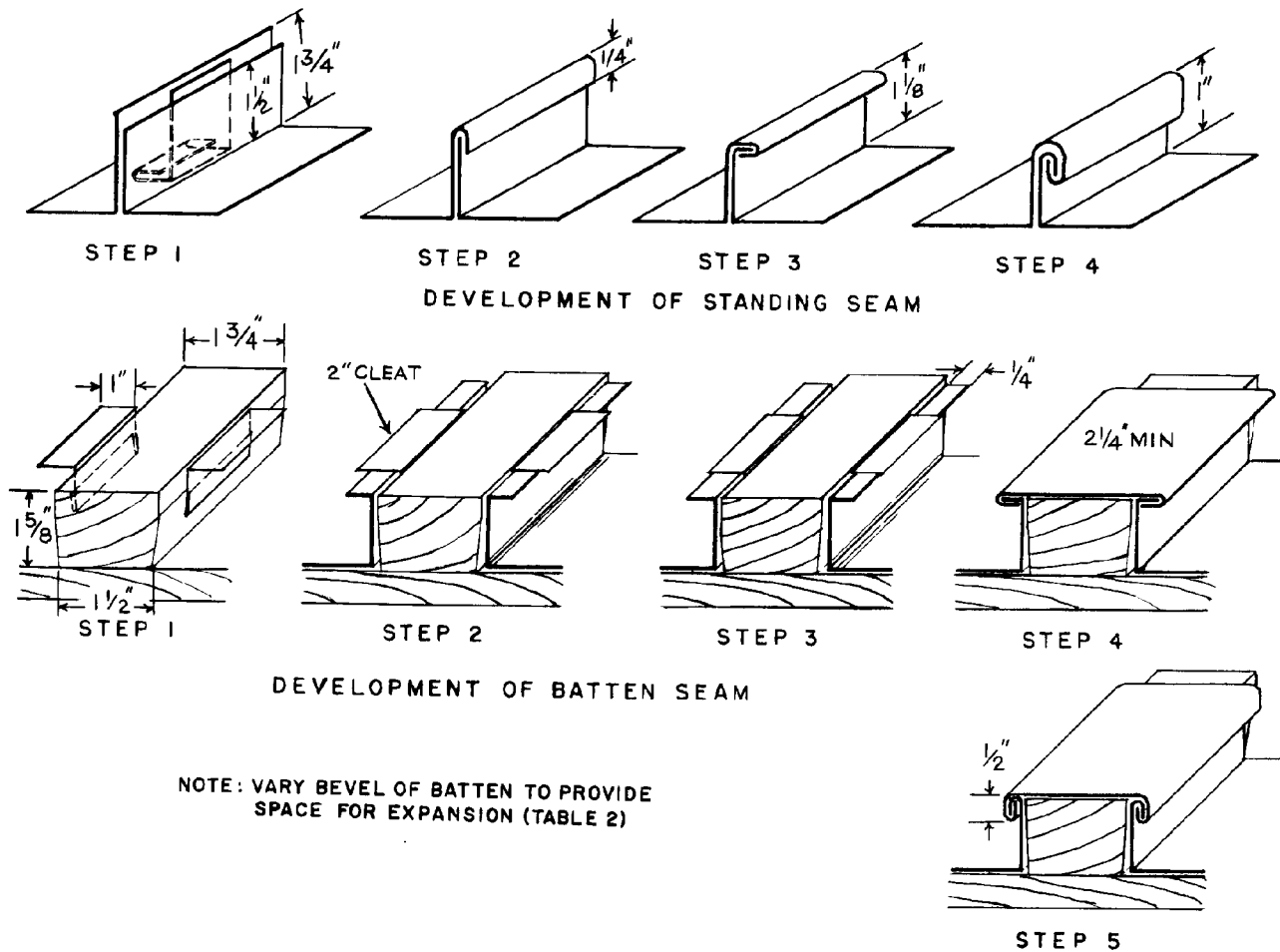

Figure 40. Development of standing and batten seams.

**11.1.5.1.3 Flat-Seam Roofing.** Flat-seam roofing, forming a continuous sheet, is adaptable to low-pitched roofs, preferably not less than  $\frac{1}{2}$  inch per foot, to insure proper drainage. Small sheets, usually 14 by 20 inches, are fastened to the roof deck by means of cleats, one end of which is locked-in to the sheet and the other nailed to the roof deck. A flat-lock seam (fig. 43 and fig. 44) is then formed at the juncture of the sheets and the seams sealed with solder. While the sheets are held in place firmly by the cleat and sufficient elasticity is provided to take care of expansion and contraction, large roof areas covered by this method should have the extremities of the roof covering free or expansion joints should be provided at intervals of 30 to 48 feet. An expansion batten section is recommended because of its watertight construction (fig. 45). Flange type expansion joints are not watertight and will leak if a drain becomes clogged and the water backs up to the top of the joint. Occasionally, long sheets of roofing are applied by the flat-seam method.

**11.1.5.2 Preformed (Corrugated) Roofing.** In the corrugated or other preformed types of roofing, series of parallel alternate ridges and grooves or crests and vales (hill and valleys) are formed in flat metal sheets. Most commonly used forms are the conventional sinewave corrugation and the V-beam design. Fasteners should be of the same material as the sheets or of a type material which will not result in galvanic action. Fasteners are usually installed exposed and should be used with washers capable of sealing the penetrations. Fasteners should be of a design and so spaced as to be capable of resisting blow-off of the roofing sheets. Both end and side laps should be sealed between sheets with mastic sealing compound, a bead for gun application or a ribbon for tape application. In localities subject to driving rains or severe ice or snow conditions and where the slope is less than 4 inches to the foot, and side laps should be increased in accordance with guide specifications for new construction. Roofing sheets should be laid with crowns or ridges in the direction of the roof slope, starting at the end of the building that is opposite the prevailing wind



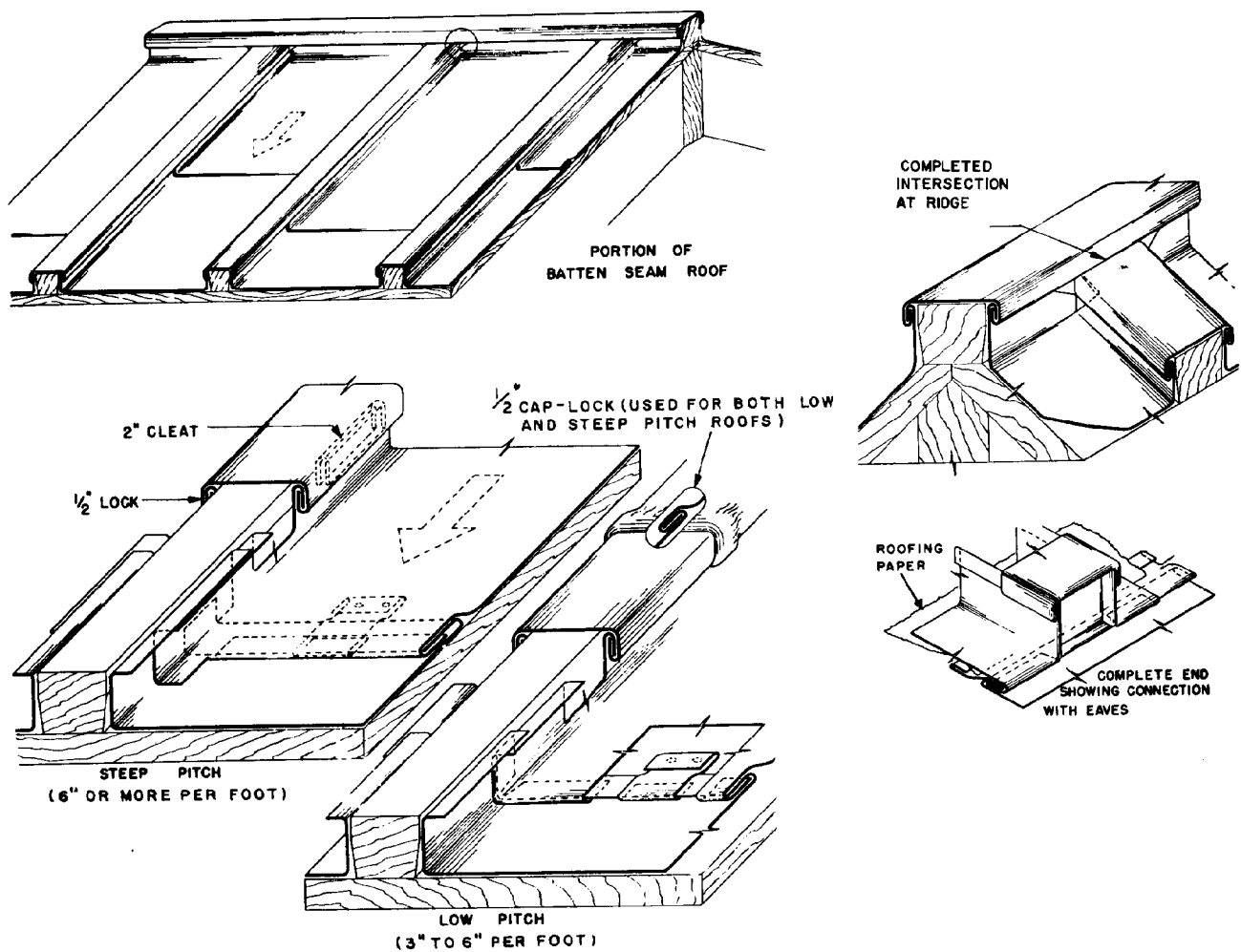

Figure 41. Batten seam roofing.

direction (fig. 46). Rubber end seals are utilized to provide water tight joints at eaves, ridges, and flashings as required.

**11.1.5.3 Unit Roofings.** So-called metal shingles made to simulate the appearance of slate and forms made to simulate the various kinds of tiles comprise most metal unit roofings. Because of the small size of unit roofings, no provision for expansion and contraction is necessary.

### 11.1.6 Fire Protection

Metal roofs, generally, are not classified as regards resistance to fire hazards. However, structures with metal roofs usually are eligible for the lowest insurance rates because of the protection afforded from falling sparks and embers.

### 11.1.7 Soldering

Soldering (Military Specification MIL-S-6872) is a process of joining two metals together by melting a third metal (at temperatures below 1,000° F) and

allowing it to flow between the metals being joined. The bond formed is mechanical and relatively weak; therefore, it is primarily used as a sealer or for joining where strength is not required. In sheet metal work, solder is generally used in conjunction with seams to provide a watertight seal and to strengthen the seam. The process of soldering consists of cleaning the two metals, applying flux, heating the two metals to the melting temperature of solder, applying the solder, and allowing the metals to cool slowly and undisturbed.

**Caution:** Fumes generated by the heating of flux are usually acid or toxic. Soldering operations should only be accomplished in well-ventilated areas. Personnel must take every precaution to avoid breathing these fumes.

#### 11.1.7.1 Types of Solder.

(1) Half and half tinnars solder consists of ½ tin and ½ lead. This alloy has a melting temperature of 415° F and a shear strength of 5,240 psi (pounds

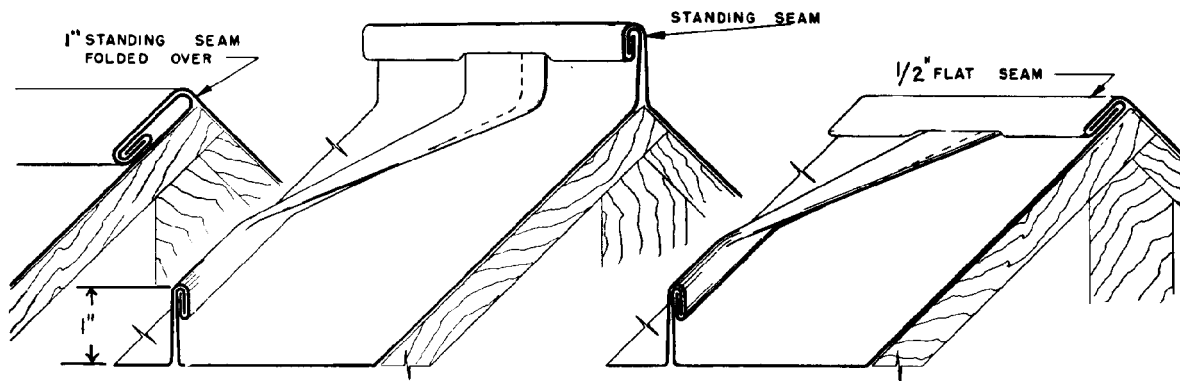

RIDGE DETAILS

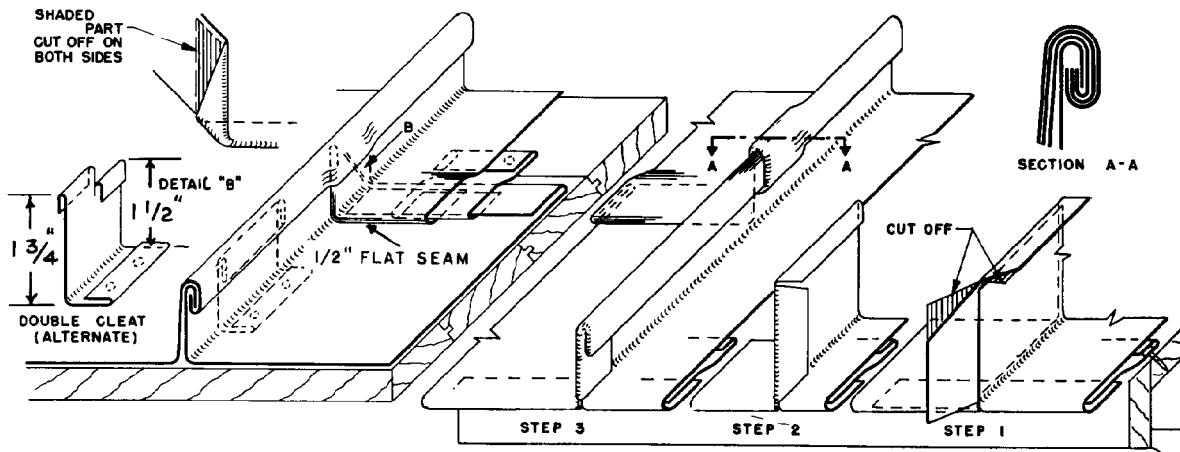

TYPICAL BAY-STANDING SEAM METHOD

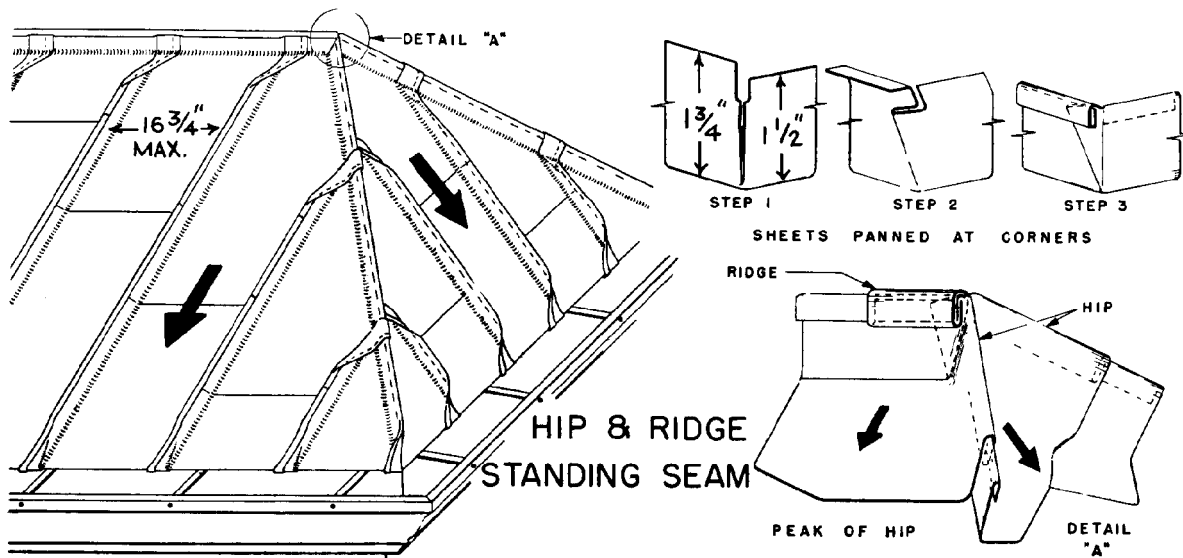

Figure 42. Standing seam roofing.

per square inch) and is the most frequently used solder.

(2) Two-thirds tin and 1/3 lead is used where increased strength is required. This alloy melts at 360° F and has a shear strength of 6,230 psi and is used for joining stainless steels.

(3) Soft solder contains 95 percent tin and 5 percent antimony and is used for soldering brass and copper and places where a low melting temperature is required.

(4) Silver solder is used where more than ordinary strength is required. Silver can be added

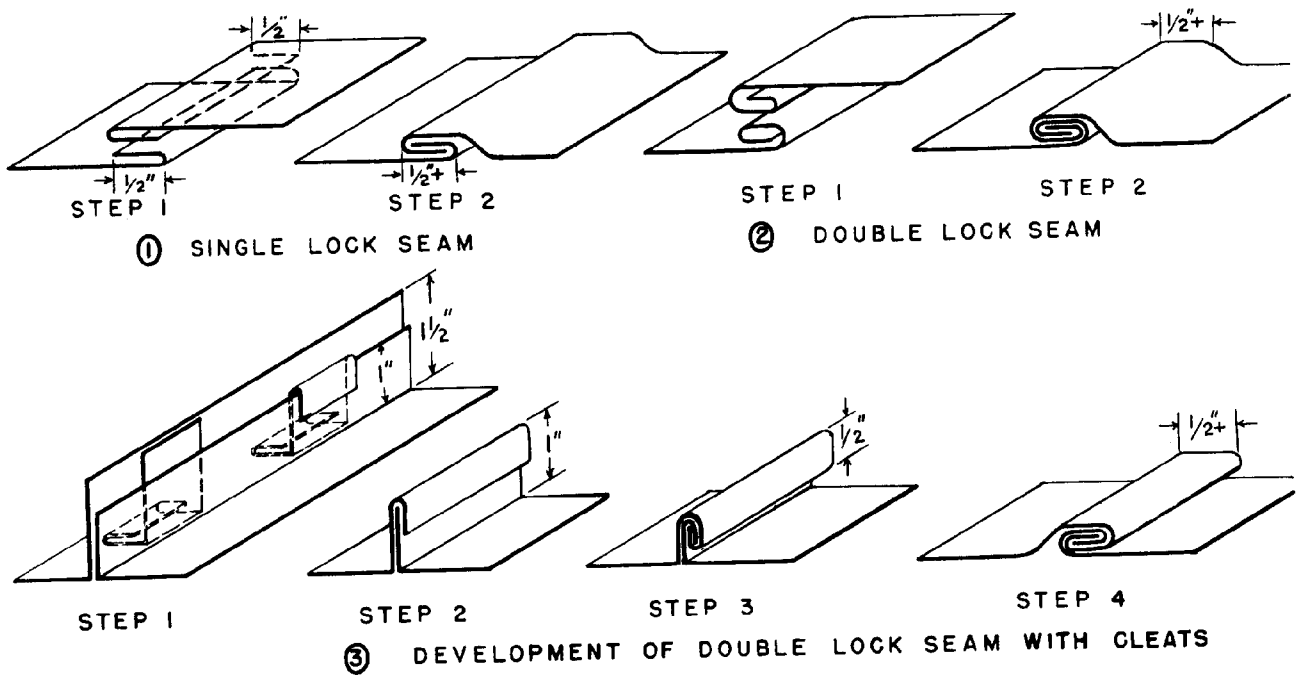

- (1) Single lock seam.
- (2) Double lock seam.
- (3) Development of double lock seam with cleats.

Figure 43. Development of lock seams.

to copper-zinc brazing alloy or alloyed with copper in varying compositions to obtain a desired melting temperature. Besides being strong, these alloys are malleable, ductile, corrosion resistant, and nontoxic.

(5) Aluminum solders are alloys of tin, zinc, and small quantities of aluminum. Small quantities of copper and lead are sometimes added. The solders are strong and ductile and are classed as hard solders requiring a blow torch for application.

**11.1.7.2 Types of Flux.** Flux (Fed Spec 0-F-506) is used to remove the existing oxide film on metals and to prevent further oxidation during the soldering process. The use of flux is necessary to insure a good bond between metal and solder.

(1) Raw muriatic acid is frequently used on galvanized surfaces and zinc as a flux and on other surfaces as a cleaner before applying flux. This acid destroys zinc and zinc-coated surfaces rapidly and must be washed off immediately after soldering is completed.

(2) Cut muriatic acid, also known as zinc chloride, is made by adding small pieces of zinc to raw muriatic acid until the solution is saturated and the reaction ceases. Cut muriatic acid is used as a flux for terne plate, copper, brass, black iron, monel, copper-nickel alloy, bronze, and nickel. It is also used on stainless steel following an application of raw muriatic acid and on aluminum after the surface has been tinned.

(3) Block or powdered rosin is less corrosive than acids and is preferred for tin or lead coated (pretinned) surface. The block and powdered forms are applied after the metal has been heated.

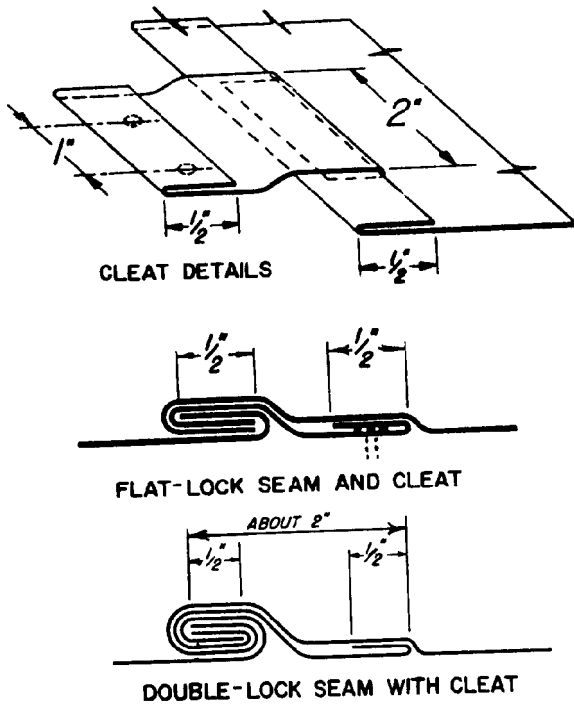

Figure 44. Typical details of cleats.

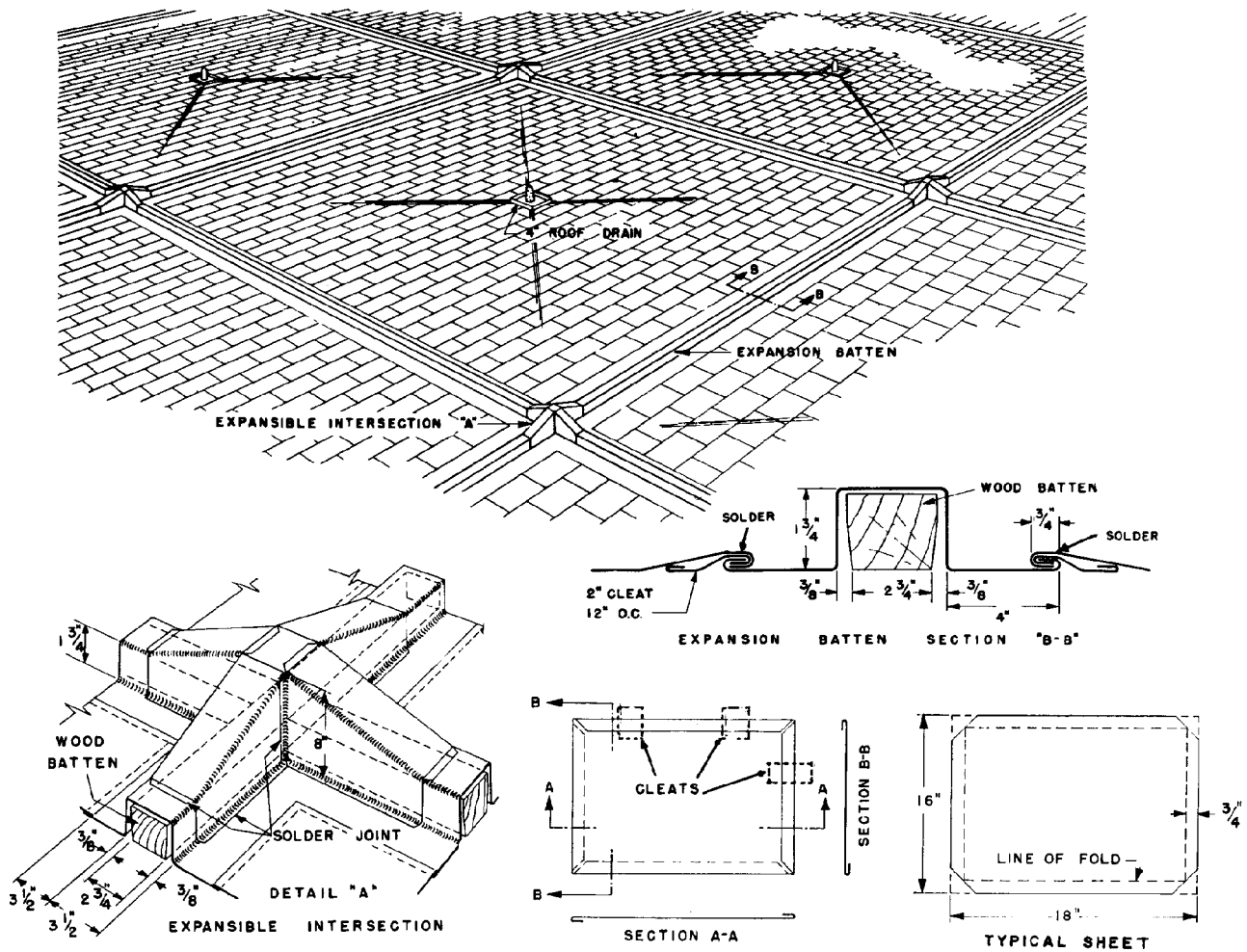

Figure 45. Flat seam roofing.

(4) Tallow is used for soldering and burning lead and in some cases, soldering aluminum.

(5) Soldering paste is a commercial product used primarily for copper wires and zinc.

(6) Sal ammoniac is generally used with a cut acid for tinning operations on large surfaces and as a flux for black iron.

(7) Phosphoric acid is an effective flux for stainless steel and usually produces better results than raw and cut muriatic acid.

11.1.7.3 *Soldering Equipment.* Equipment necessary for soldering includes solder, flux, source of heat, soldering coppers, and cleaning equipment.

(1) *Soldering Coppers.* Soldering coppers, commonly called soldering irons, are made of copper attached to an iron shank with an insulated wood handle. The weights and shapes of these coppers vary to suit the different soldering operations. Small, light work would require a small iron with a sharp point. Heavy work such as roof

seams would require a large iron with a blunt point. The coppers should be cleaned and dressed with a file if necessary, heated dipped in flux, and pretinned before soldering. Untinned and undressed soldering coppers have poor heat transfer and usually result in an unsatisfactory soldering job.

(2) *Source of Heat.* Sources of heat vary from electric heating elements built into the soldering copper to blow torches. For shop work, the coppers are usually heated in bench mounted gas or electric furnaces. For on-the-job work, they are usually heated in gasoline-fired furnaces, stands adapted to blow torches, or charcoal pots.

(3) *Cleaning Equipment.* Cleanliness is essential both before and after soldering. Before soldering, the work must be free of all paint, grease, dirt, and corrosion to insure a good bond and prevent voids in the solder. After soldering, the

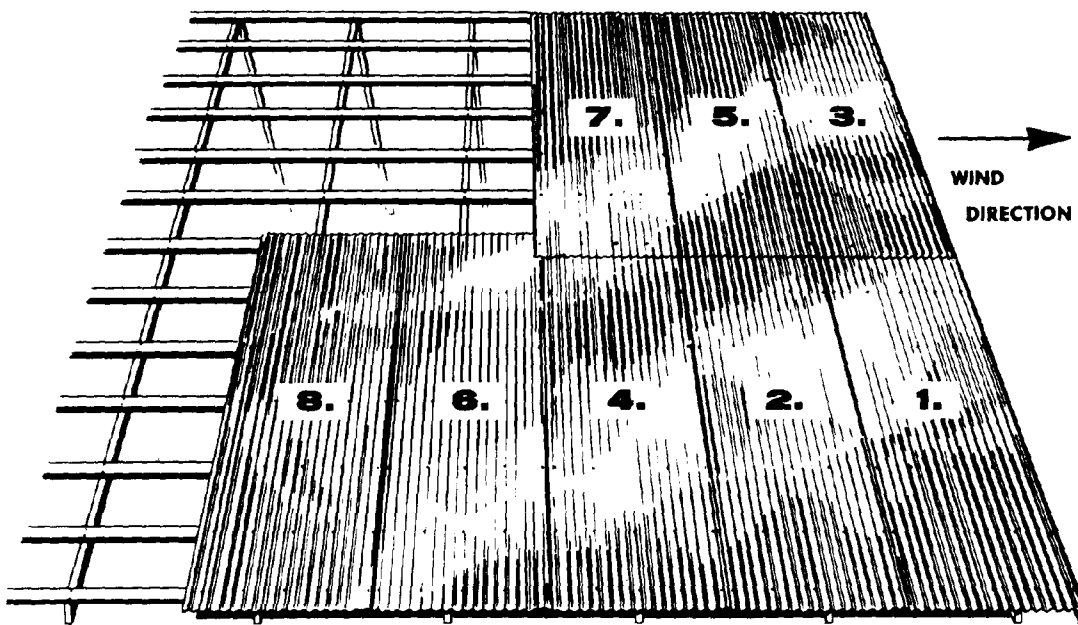
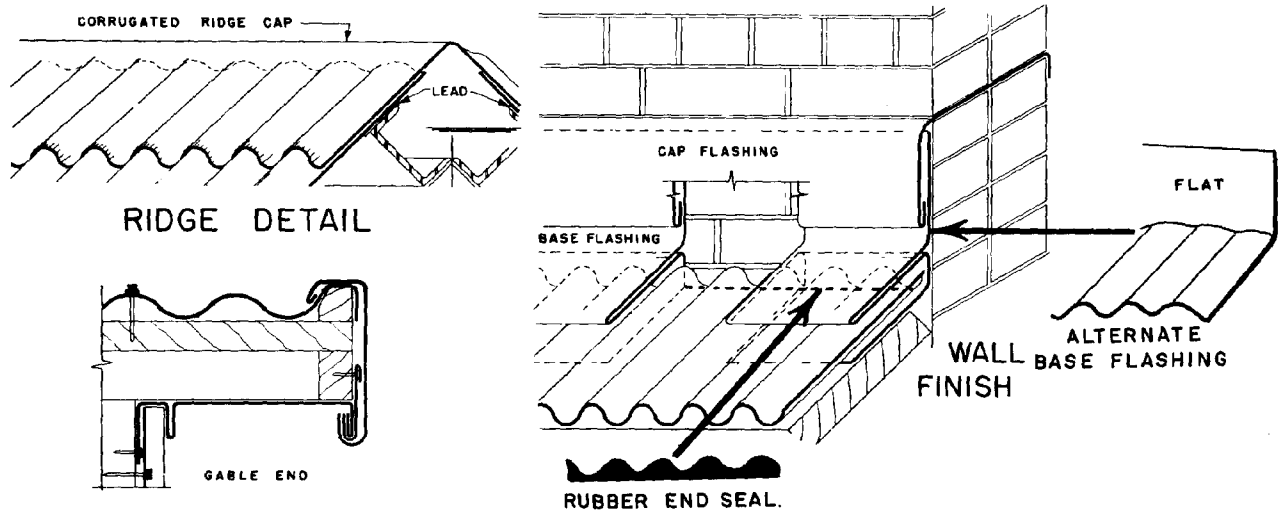

NOTE: PROVIDE A LIBERAL CALKING BEAD BETWEEN EACH END AND SIDE LAP OF SHEETS AND ACCESSORIES

Figure 46. Corrugated roofing.

work must be cleaned to prevent corrosion and staining by the flux. Corrosion can be removed with wire brushes, sandpaper, or emery cloth. Paint and heavy deposits of grease can be removed with solvents (MIL Spec MIL-C-11090). Dirt and light grease should be removed with water and detergents (MIL Spec MIL-D-16791). After soldering, all traces of flux should be removed with solvents followed by a thorough washing with detergent and water, and drying with clean, dry cloths.

Note. Naptha (MIL-N-15178), kerosene (Fed Spec VV-K-211), diesel oil (Fed Spec VV-F-800), and turpentine (Fed

Spec TT-T-801), may be used as solvents. However, these solvents are flammable and should not be used if nonflammable, low-toxicity, solvents will serve the purpose equally as well.

**11.1.7.4 Soldering Practices.** Good soldering practices include -- keeping the work clean; pre-tinning metals that are not coated with lead or zinc; using the proper solder and flux; keeping the equipment in serviceable condition; drawing the copper along the work slowly to allow full penetration of the heat; not disturbing the work until the solder has hardened; removing all traces of flux after soldering. Insufficient heat or moving the joint before the solder is completely solid will result

in a cold joint. Good soldering joints are smooth and uniform. Cold joints have high uneven spots and appear to have a crystallized structure.

### 11.1.8 Thickness of Sheet Metals

The thickness of metal sheets is determined by gage, decimal fractions of an inch, weight per square foot, or a combination of two methods. Two scales of gage thickness are commonly used; the Brown and Sharpe or American Standard for nonferrous wire and sheet metal; and the United States Standard for iron and steel plate. Table 3 lists the common gages of sheet metal with the decimal equivalent for each standard. The weight per square foot system is commonly used for nonferrous metals. A combination of two systems is used for clad metals where the base sheet is measured by gage number and the protective coating is measured in weight per square foot. An example of this would be galvanized iron where the black iron sheet is generally 26 gage coated with 1.25 ounces of zinc per square foot. The thickness of sheet metal is measured with either a slotted metal gage or a micrometer. The number of the slot into which the metal fits snugly without forcing indicates the gage of the metal. Micrometer readings should be taken at intervals to determine the average thickness of the sheet. Micrometer readings are in decimal fractions of an inch and can

be converted to the nearest gage number by using table 3.

Table 3. Sheet Metal Gages\*

Gage No.	Brown & Sharpe	United States	United States
	or American Standard for nonferrous wire and sheet metal	Standard Galvanized and Black Iron	Standard Stainless Steel
8	0.1285	0.1644	0.1719
9	0.1144	0.1494	0.1562
10	0.1019	0.1345	0.1406
11	0.0907	0.1196	0.1250
12	0.0808	0.1046	0.1094
13	0.0720	0.0897	0.0938
14	0.0641	0.0747	0.0781
15	0.0571	0.0673	0.0703
16	0.0508	0.0598	0.0625
17	0.0453	0.0538	0.0562
18	0.0403	0.0478	0.0500
19	0.0359	0.0418	0.0438
20	0.0320	0.0359	0.0375
21	0.0285	0.0329	0.0344
22	0.0253	0.0299	0.0312
23	0.0226	0.0269	0.0281
24	0.0201	0.0239	0.0250
25	0.0179	0.0209	0.0219
26	0.0159	0.0179	0.0188
27	0.0142	0.0164	0.0172
28	0.0126	0.0149	0.0156
29	0.0113	0.0135	0.0141
30	0.0100	0.0120	0.0125

\*Dimensions in decimal parts of an inch.

## Section II. ROOF DECKS FOR METAL ROOFINGS

Metal roofings are applied on solid or open-slat wood decks, or on wood or metal framing (purlins). Solid wood decks may be of well-seasoned, tongued-and-grooved, square edged or ship-lap sheathing laid to produce a smooth, uniform surface. Solid decks may also be of plywood with exterior glue. Before applying the metal, the deck must be dry, and care should be taken to insure that the surface is clean and smooth, with no rough spots or projections such as nail heads, wood chips,

stones, or other debris. In open-slat decks, the sheathing boards may be spaced from 6 to 24 inches, depending on the rigidity of the roofing to be applied. Only the more rigid sheet roofings, usually corrugated, are laid on purlins without sheathing. Metal roofing may also be laid over concrete or gypsum roof decks. Some underlay material such as asphalt-saturated felt is usually applied under metal roofing on tight decks. Contact of dissimilar metals should be avoided.

## Section III. STORAGE AND HANDLING OF METAL ROOFING

Metal roofings in storage should be protected from the weather. Although some metal roofings are intended for direct exposure to the weather, some, such as copper, may become stained and others, such as galvanized steel, may corrode if stored in a damp place. Bundles of sheeting should be opened and inspected when received. Damp or wet

sheeting should be separated and dried. Stained sheeting should be cleaned before use. Metal sheets should be stored on edge, not in contact with the ground. Sheets should be carefully handled at all times to prevent damage to the surfaces, edges, and ends.

## Section IV. TREATMENT FOR METAL ROOFS

Since the different metal roofing materials normally require different treatments, they are considered separately in this section.

### 11.4.1 Copper Roofing

*11.4.1.1 General.* Copper is one of the least chemically active metals used for roofing. Consequently, copper roofings of adequate weight, applied properly, render long service. The weight of copper roofing is designated as ounces per square foot. Sixteen-ounce copper is the generally accepted weight for roofing. Sheets of this weight are approximately 0.0216 inches thick and when applied by the standing-seam method, weigh approximately 125 pounds per square. Copper roofs are usually applied by the flat-seam, batten-seam, or standing seam methods.

*11.4.1.1.1 Patina.* When copper roofing is exposed to the atmosphere, a green coating known as patina forms on the exposed surface. This coating aids in protecting the metal from further corrosion.

*11.4.1.1.2 Lead-Coated Copper.* Lead-coated copper is occasionally used for roofing. While this is a case of dissimilar metals in contact, lead and copper are adjacent in the electromotive series so that little action would be expected in any case. Since lead has the lower number, it protects the copper electrolytically as well as physically. Lead-coated copper is used advantageously to prevent copper staining on the surrounding materials.

*11.4.1.2 Temper.* Copper sheet metal is produced in varying degrees of hardness, but is generally divided into two groups that are best suited for general purpose work in structures. "Soft" is the term given to soft rolled, hot rolled, or roofing temper and is used for standing and batten seam roofing, caps, and through-wall flashings. "Cold" rolled is the term given to hard, hard rolled, or cornice temper and is recommended for most general purpose construction work, especially base and counter flashings, gutters, downspouts, and other places where stiffness is required to support or maintain the shape of an item.

*11.4.1.3 Workability.* Copper is soft and ductile permitting the use of all types of seams for joining and folds for forming operations. Cold working hardens copper. Repeated folding, bending, or hammering should be avoided or the copper must be annealed to restore its ductility.

*11.4.1.4 Galvanic Action.* Because of its position in the electrochemical series, copper is seldom damaged by galvanic action. However, the

presence of copper can electrically corrode other metals if precautions are not used.

*11.4.1.5 Fasteners, Seams, and Joints.* All mechanical fasteners should be made of copper. Cleats are generally used to secure sheets of copper. Copper is ductile which permits easy forming for various types of seams for joining. For water tight joints, copper is readily soldered. For water tight joints as in roofing where freedom of movement is desired, paste sealers or expansion joints are recommended. Two types of sealers are commonly used; a paste containing 92 percent lead carbonate and 8 percent linseed oil or a mixture of asphalt and asbestos fiber (Fed Spec SS-C-153). The lead paste is usually specified.

*11.4.1.6 Reuse of Copper.* The reuse of copper is recommended because of its high cost and ductility which permits reworking. However, care must be exercised to prevent metal fatigue where the metal was previously creased or stressed.

*11.4.1.7 Maintenance.* Copper roofs do not normally require maintenance as defined for this manual. Any treatment necessary would be classed as a repair, following failure (leak).

*11.4.1.8 Repairing to Provide Adequate Expansion and Construction.* The most common cause of failure in copper roofs is the failure to provide adequately for expansion and contraction, particularly in flat-seam roofing. Broken soldered seams and breaks in the metal at points other than seams indicate inadequate provision for expansion and contraction.

*11.4.1.8.1 Flat-Seam Roofs.* When broken soldered seams indicate inadequate provision for expansion and contraction, new expansion joints sufficient to provide a joint at intervals of not more than 10 feet in each direction should be installed.

*11.4.1.8.2 Batten and Standing-Seam Roofs.* If soldered horizontal seams on batten- and standing-seam roofs are broken, loose lock seams that permit movement of the sheet should be installed at those points.

*11.4.1.9 Repair Breaks in Copper Roofing.*

*11.4.1.9.1 Small Breaks.* Small holes in copper roofing can be repaired with a drop of solder. In soldering copper, scrape with a sharp instrument or emery cloth until bright metal shows on any surface that is to contact the solder. Then apply zinc chloride or rosin as a flux and tin the surface with a thin coating of solder.

*11.4.1.9.2 Larger Breaks.* Larger breaks, not caused by inadequate provision for expansion and

contraction, may be repaired by soldering a piece of copper over the hole; the new metal should be mechanically locked to the existing sheet.

#### *11.4.1.10 Reroofing with Copper Roofing.*

##### *11.4.1.10.1 Preparing Deck for Reroofing with Copper Roofing.*

Restore the deck to as nearly "new" condition as possible as follows:

- (1) Remove all protruding nails and re nail sound sheathing where necessary.
- (2) Remove rotted or warped sheathing boards and install new decking.
- (3) Cover all large cracks, knot holes and resinous areas with compatible sheet metal.
- (4) Repair or replace copper flashings.

*11.4.1.10.2 Applying Copper Roof.* Apply copper roof in accordance with current specifications for new construction.

## **11.4.2 Terne Roofing**

*11.4.2.1 General.* Terne (tin) roofing is composed of a steel sheet coated on both sides with a lead-tin alloy.

*11.4.2.1.1 Grades.* Terne sheets are usually furnished in grades 1C (approximately No.30 US Gage) and 1X (approximately No. 28 US Gage). Grade 2X (approximately No. 26 US Gage) is also available. The 1C grade, weighing approximately 65 pounds per square, is generally used for flat-seam, batten-seam and standing-seam roofing. The 1X grade, weighing about 25 percent more than the 1C grade, is normally used for flashings, valleys and box gutters. Sheets are commonly available in two sizes, 14 by 20 inches and 20 by 28 inches. Rolls 14, 20, 24, and 28 inches wide by 50 feet long are also available.

*11.4.2.1.2 Weight of Lead-Tin Coating.* The weight of lead-tin coating for terne sheets is designed as "pounds per double base box," a double base box consisting of 112 sheets, 20 by 28 inches (62,720 square inches). Coating weights of 40 pounds per double base box and 20 pounds per double base box are generally used. For maximum longevity, 40-pound coating should be used.

*11.4.2.1.3 Painting.* It is necessary to keep terne roofing well painted for long service. The reason is that the lead-tin alloy, while furnishing good physical protection to the iron or steel base, is so placed in the electromotive series that the coating will be preserved at the expense of the ferrous base in cases where pinholes or scratches in the coating expose the base. The underside of terne roofing should be painted with a mill applied shopcoat or a coat of red iron oxide-linseed oil paint.

*11.4.2.2 Coefficient of Expansion.* The coefficient of expansion of terne sheets is only

about 2/3 that of copper, therefore, expansion and contraction with changes in temperature is less of a problem. In addition, the lighter weights of terne sheets that are used permit slight buckling.

*11.4.2.3 Temper.* The temper of terne plate is dependent upon the mild steel sheet under the coating and is copper bearing steel of low carbon content similar to galvanized iron.

*11.4.2.4 Fasteners, Seams, and Joints.* Lead coated fasteners should be used with terne plate. The lead-tin coating will withstand severe folding and bending before breaking down and can be utilized in all forming and bending operations. Soldering is recommended for all seaming and joining operations. The lead-tin coating eliminates the necessity of pre-tinning. Brazing and welding destroy the coating in the area of the weld and are not recommended.

*11.4.2.5 Maintaining Terne Roofs.* Terne roofs must be maintained by periodical painting. The frequency of painting will vary with different conditions of exposure, but painting should never be put off until rust appears. Do not build up too thick coatings of paint by too frequent painting. Instructions for painting terne roofs are given in manufacturer's literature. A linseed oil and iron oxide (FS-TT-P-31) primer is recommended followed by oil exterior paint.

*11.4.2.6 Repairing Terne Roofs.* Many leaks in terne roofings are caused by faulty seams.

*11.4.2.6.1 Broken Soldered Seams.* Broken seams are generally due to improper soldering. Seams should be opened up and cleaned before resoldering. The presence of moisture in seams will not permit proper penetration of solder. Half and half solder is used for terne. Rosin is used as a flux. Remove excess rosin before painting.

*11.4.2.6.2 Leaky Formed Seams.* Repair leaky formed seams by reforming or by calking with a plastic calking material.

*11.4.2.6.3 Small Breaks.* Repair small holes in terne roofings with a drop of solder.

*11.4.2.6.4 Larger Breaks.* Larger breaks in terne roofings may be repaired by mechanically locking and soldering a piece of terne roofing over the break.

#### *11.4.2.7 Reroofing with Terne Roofing.*

*11.4.2.7.1 Preparing Deck for Reroofing.* See paragraph 11.4.1.10.1, "Preparing Deck for Reroofing with Copper Roofing."

*11.4.2.7.2 Applying Terne Roof.* Apply terne roof in accordance with specifications for new construction.



### 11.4.3 Galvanized Steel Roofing

*11.4.3.1 General.* Galvanized sheets are available in various sizes and in thickness ranging from No.12 to 30 gage (US Standard for Iron and Steel Plate) and in various weights of zinc coating, the weight of coating being expressed as the total weight of zinc per square foot on both sides of the sheet. The resistance to corrosion of galvanized sheets increases with increased weights of zinc coating. However, since the sheets are formed after the zinc coating is applied, there are practical limits to the thickness of the coating on formed sheets. The heavier coating, up to 2.74 pounds, are normally applied to the heavier gage sheets. For severe bending or forming, only thin, tightly adherent coatings are used. Zinc is an ideal coating material for iron or steel. From its position in the electromotive series, it is obvious that the base metal will be protected electrochemically by the zinc in cases where pin holes or scratches expose it, and it is only when relatively large areas of the base metal are exposed that rusting takes place. Consequently, unliketerne coated sheets, galvanized sheets may be exposed without painting. The length of such exposure depends on the weight of the zinc coating and the conditions of exposure, but painting may be postponed safely until the first sign of base metal corrosion appears. This will be in the form of a rather bright yellow product resulting from the corrosion of the zinc-iron alloy formed on the surface of the base metal.

*11.4.3.2 Forms.* The common types of galvanized roofing are V-crimp, corrugated, pressed standing seam, rolled roofing, and shingles. All but the roll roofing are preformed, ready to apply. Other special shapes of preformed sheets are also available. Corrugated galvanized roofing is taken as representative of the galvanized metal roofings, since it is the type of galvanized roofing used most frequently on warehouses, sheds, and other industrial type facilities. It is the lowest in cost of all types of metal roofing and, when properly applied and maintained, it renders very satisfactory service. Corrugated galvanized roofing may be applied over tight wood decks, with or without underlay, on open-slat decks or on wood or steel purlins. It is available in sheets of different lengths and depths of corrugations. Full length sheets should be used when possible to eliminate end laps between the eaves and the roof ridge.

*11.4.3.3 Temper.* The steel sheets are a low carbon steel and provide the maximum strength without sacrificing ductility. Any attempt to increase the temper by heating and quenching will

destroy the zinc coating. Excessive cold working will crack the zinc surface.

*11.4.3.4 Fasteners.* All fasteners must be galvanized (lead or zinc coated), stainless steel or other type which will not result in galvanic attack on the sheet.

*11.4.3.5 Maintaining Galvanized Steel Roofing.* The most frequent causes of failure in galvanized roofings are improper application and lack of regular maintenance painting. Leaks at seams and fasteners are evidence of improper application. Galvanized steel roofs need not be painted immediately upon exposure. In fact, without special treatment or the use of special paints, it is better to postpone painting of galvanized steel for several months, at least, to insure adhesion of the paint. Painting may be postponed until the appearance of bright yellow corrosion product indicating that the zinc coating is no longer protecting the zinc-iron alloy formed on the surface of the base metal. However, it is much safer to paint prior to the appearance of this product and subsequent regular maintenance painting will prolong the service of the roofing indefinitely. Instructions for painting galvanized steel roofs are given in the tn-services paint manual. New galvanized surfaces should receive an application of wash primer (MIL-C-14504) to provide proper adhesion of paint followed by a coat of zinc dust-zinc oxide paint (F.S. TT-P-641) and an appropriate finish coat.

*11.4.3.6 Repairing Galvanized Steel Roofing.*

*11.4.3.6.1 Leaks at Seams and Fasteners.* Inadequate laps in galvanized steel roofings may be repaired by calking the seams or, in severe cases where calking is impracticable, by stripping the laps as described in paragraph 6.6.4.2.1, "Repairing Leaky Seams of Roll Roofings for an Expected Use of More than 1 Year." As stated in this reference, modifications of the method, following the same principle, may be satisfactory. With any method, workmanship is extremely important. It should be realized, also, that repairs of this kind cannot be expected to last as long as the galvanized sheets so that they will require maintenance treatment and probably renewal at intervals. When exposed fasteners are a part of the lapped seam, the membrane treatment should be applied over them.

*11.4.3.6.2 Repairing Breaks in Galvanized Steel Roofing.* Breaks in galvanized steel roofing are best repaired by replacing the defective sheet of roofing with a new one.

*11.4.3.7 Reroofing with Galvanized Steel Roofing.*

*11.4.3.7.1 Preparing Deck for Reroofing.* See paragraph 11.4.1.10.1, "Preparing Deck for Reroofing with Copper Roofing."

*11.4.3.7.2 Applying Galvanized Steel Roof.* Apply galvanized steel roof in accordance with current specifications for new construction.

#### **11.4.4 Aluminum Roofing**

*11.4.4.1 General.* Aluminum roofing materials may be homogeneous, with the entire cross section of the same composition, usually not less than 97 percent of aluminum or they may be called clad materials, with a layer of aluminum or aluminum alloy that is anodic to the core material and which will retard corrosion of the core material if it is exposed. The usual core material is an aluminum alloy. Aluminum coated steel sheets are also used. The thickness of aluminum sheets is usually measured in decimal fractions of an inch as opposed to a gage number or weight measure. When gage is referred to it is the Brown and Sharp (American Standard) System. Aluminum roofings are available in essentially the same forms as galvanized steel, namely V-crimp, corrugated, pressed standing seam and shingles. Other special shapes are also available. Sheets are produced in various sizes and thicknesses and in varying degrees of temper. Aluminum roofing when properly applied, renders excellent service. It is similar to copper roofing in that it does not require painting. However, it should be noted that aluminum has a high coefficient of expansion and is subject to galvanic action from other metals.

*11.4.4.2 Coefficient of Expansion.* The coefficient of thermal expansion of aluminum is approximately  $\frac{1}{3}$  greater than that of copper so that ample provision for expansion and contraction must be supplied when long sheets of aluminum roofing are used.

*11.4.4.3 Galvanic Action.* Aluminum is the most active of structural metals and decomposes rapidly when in contact with other metals. Therefore, contact of aluminum roofing with dissimilar metals must be avoided, particularly in coastal areas. This precludes the use of bare steel and copper nails, or lead washers, in such areas. Aluminum alloy nails should be used with aluminum alloy roofing to obtain the best results.

*11.4.4.4 Temper.* For general construction work, aluminum is classified as soft or hard. The letter A (commercially 0) denotes soft and the letter H denotes hard.

*11.4.4.5 Workability.* Aluminum is ductile and will withstand a 180° bend without fracture. Cold

working rapidly hardens aluminum; therefore, straightening, refolding, or reworking will usually fracture the affected area. To trim light gauge soft temper corrugated aluminum perpendicular to corrugations, scribe deeply, and tear by forceful rolling of cut off portion.

*11.4.4.6 Contact with Masonry.* Direct contact with mortar, lime, cement, and wood should be avoided to prevent corrosive action between the receiving surface and the aluminum. Masonry surfaces (line, mortar, concrete, plaster, etc.) must be coated with alkaline-resistant coatings such as heavy bodied bituminous paint or water-white methacrylate lacquer. Wood can be treated with bituminous paint, or two coats of either aluminum house paint, pentachlorophenol (5 percent minimum concentration), Wolman salts, creosote, or zinc naphthenate. Wood may also be covered with waterproof building paper.

*11.4.4.7 Fasteners and Seams.* Only aluminum fasteners should be used to secure aluminum sheets because of its high affinity for galvanic action. Soldering of aluminum, although possible, is not recommended. In thickness less than .040 inch, mechanical fastenings should be used, and for greater thickness, aluminum is usually welded using a shield of inert gas.

*11.4.4.8 Maintaining Aluminum Roofing.* Aluminum roofing, properly applied, does not normally require maintenance. However, if evidence of severe atmospheric corrosion occurs, the roofing may be preserved by regular maintenance painting. Instructions for painting aluminum are given in the tin-service paint manual.

*11.4.4.9 Repairing Aluminum Roofing.* Failures in aluminum roofing that are due to improper application are essentially the same as those encountered with galvanized steel roofing and are repaired similarly. See paragraph 11.4.3.5, "Repairing Galvanized Steel Roofs."

*11.4.4.10 Reroofing with Aluminum Roofing.*

*11.4.4.10.1 Preparing Deck for Reroofing.* See paragraph 11.4.1.10.1, "Preparing Deck for Reroofing with Copper Roofing."

*11.4.4.10.2 Applying Aluminum Roofing.* Apply aluminum roofing in accordance with current specifications for new construction.

#### **11.4.5 Corrosion-Resisting (Stainless) Steel**

*11.4.5.1 General.* Corrosion-resisting steels (ASTM Standard A167) are alloys of steels with varying compositions of chromium, nickel, and copper. Most of the structural stainless steels are of

a chrome-nickel-steel alloy and are austenitic in nature which means they cannot be heat treated but must be cold worked to alter their physical characteristics. Chromium stainless steels contain no nickel and are martensitic (less than 18 percent chrome) or ferritic (18 to 30 percent chrome) in nature. Their physical characteristics can be changed with heat treatment. AISI (American Iron and Steel Institute) numbers are generally used to differentiate between the stainless steels. Composition ratios are also used. The first and the second number indicates the percentage of nickel alloyed with steel. The thickness of stainless steel sheet is usually determined by gage number (US Standard for Iron and Steel Plate). On military facilities, the use of stainless steel for roofing is generally limited to drainage and flashing applications because of the high initial cost.

**11.4.5.2 Types.** Types of stainless steel commonly used for roofing are AISI 301 ( $^{16}/_{18}-^{6}/_{8}$  composition), AISI 302 ( $^{17}/_{19}-^{8}/_{10}$  composition.) AISI 304 ( $^{18}/_{20}-^{8}/_{12}$  composition), and AISI 316 ( $^{16}/_{18}-^{10}/_{14}$  composition). Type 316 has 2 to 3 percent molybdenum added which increases corrosion resistance.

**11.4.5.3 Finish.** Stainless steel sheets are available with several surface finishes. Finish No. 2D is usually preferred for roofing and flashing applications.

**11.4.5.4 Coefficient of Expansion.** Stainless steel (300 series) has a coefficient of expansion of 0.0000096 which is about 50 percent greater than the coefficient of expansion for carbon steels.

**11.4.5.5 Workability.** Stainless steel sheet and strip material is readily formed by sheet metal shop tools. For roofing and flashing work, the stainless steel should be furnished in the annealed condition. Stainless steel is ductile enough to permit all of the seams applicable to sheet metal work.

**11.4.5.6 Soldering.** Stainless steel can be soft-soldered, using the same equipment and procedures as used with other roofing metals. A strong acid flux is required. After soldering, flux residue should be rinsed off. Ordinary "half-and-half" tin-and-lead solder is suitable. However, a 60-40 tin-and-lead solder should be used where appearance is a consideration. Solder should be used only to fill or seal the joint; it should not be relied upon to provide joint strength. Mechanical fastening or welding should be used if strength is an important factor.

**11.4.5.7 Fasteners.** Fasteners must be of stainless steel. Ordinary iron or steel fasteners corrode and leave rust deposits on the surface of

stainless steels.

**11.4.5.8 Maintaining Stainless Steel Roofing.** Other than routine maintenance inspections, the only periodic maintenance required with stainless steel is cleaning. Normal cleaning is accomplished with mild detergent and water. Heavy accumulations of dirt containing oil or grease will require solvents. Organic solvents are usually satisfactory and will not harm the finish. Other deposits or stains require the use of stainless steel wool or abrasives. Use only stainless steel wool and scraper. Ordinary steel wool and scrapers will contaminate the surface and eventually leave rust stains. Recommended abrasives include fine grade whiting or pumice, stainless steel cleaners, fine grade commercial scouring powders, and abrasive metal cleaners. Abrasives must be applied with a soft, damp cloth, and rubbed lightly to prevent scratching of highly polished surfaces or bright spots in a dull surface.

**11.4.5.9 Repairing Stainless Steel Roofing.** Repair methods are similar to those for copper roofing. See paragraphs 11.4.1.8 and 11.4.1.9.

**11.4.5.10 Reroofing with Stainless Steel.**

**11.4.5.10.1 Preparing Deck for Reroofing.** See paragraph 11.4.1.10.1, "Preparing Deck for Reroofing with Copper Roofing."

**11.4.5.10.2 Applying Stainless Steel Roofing.** Apply stainless steel roofing in accordance with current specifications for new construction.

## 11.4.6 Protected Metal Roofing

This type roofing consists of a steel or aluminum base sheet that is protected from the weather by a factory-applied covering. Coverings are applied to flat sheets, before forming, and include liquid coatings, liquid plus film coverings, and film coverings. Protected metal roofing is available in various colors and in the same configurations as galvanized steel and unit weights depending on the gage of the metal core, the type of metal, and the type of covering. Protected metal roofings are proprietary materials. Consequently, with these materials, the recommendations of the manufacturer should be followed as regards storage and handling, application, maintenance and repair. With materials of this kind, it is practically impossible to avoid breaks in the protective covering during construction. To cover such breaks and to renew the protective covering when exposure makes a renewal necessary, only materials furnished by the manufacturer should be used in order to insure that the new material is compatible with the old.

Table 4. Properties of Sheet Metal

Material	Characteristics	Principal uses	Melting point (per degree F)	Coefficient of expansion (per degree F)	Method of joining	Precautions
Copper.....	High corrosion resistance. Excellent workability. Tarnishes easily but eventually forms decorative coating called patina. Toxic.	Roofing, gutters, downspouts, flashing, louvers, scuttles, drains, shower pans.	1980° F	0.0000098	Use caution when welding. Excellent for all other methods.	Water which has been in contact with copper will stain masonry and painted surfaces, and corrode most other metals.
Aluminum.....	Good corrosion resistance. Light weight. Nontoxic. Good workability. Easily cleaned.	Roofing, siding, trim, flashing, eaves.	1218° F	0.0000128	Welding requires shield of inert gas. Soldering not recommended. Braising mechanical fasteners and seams recommended.	Not recommended for extensive seaming. Highly subject to electrolytic corrosion.
Galvanized Iron...	Fair corrosion resistance. Good workability. Nontoxic. Good fire resistance.	Roofing, siding, gutters, downspouts, eaves, ventilators.	Coating 786° F Base sheet 2700° F	0.0000065	Excellent for soldering, seaming and mechanical fasteners. Welding and braising destroy galvanized surface.	Protective coating (zinc) highly subject to electrolytic corrosion. High temperatures destroy surface.
Black Iron.....	Poor corrosion resistance. Good workability. Excellent resistance to abrasion. High strength.	Floor plates, stair treads, roof decking.	2700° F	0.0000065	Excellent for all methods of joining and seaming.	Easily damaged by all corrosive elements.
Stainless Steel.....	High corrosion resistance. Good workability. Nontoxic. Easily cleaned. Work hardens rapidly.	Flashing, decorative trim, roofing, gutters, downspouts.	2560° F	0.0000058 to 0.0000098	Requires additional power for seaming. Inert gas shield not required for welding but recommended to prevent surface damage.	Extra power required for cutting and forming operations. Surface can be contaminated by iron particles, causing rust.
Nickel Copper Alloy (Monel)	Excellent corrosion resistance. Good workability. Nontoxic. Easily stained. Difficult to clean.	Roofing and drainage components (in highly corrosive atmosphere and salt water areas).	2670° F	0.0000077	Excellent for all methods. Solder offers no strength.	Surface tarnishes easily and is difficult to clean.
Terns.....	High durability if kept painted. Good workability (same as steel core). Responsive to paint. Lead-tin coating is toxic.	Roofing, flashing, and drainage components.	Base sheet 2700° F	0.0000065	Excellent for soldering, seaming, and mechanical fasteners. Pre-tinning not required for soldering. Braising and welding destroy lead-tin coating so not recommended. Use lead coated fasteners.	Painting is required.

Table 5. Use and Recommended Thickness of Sheet Metals

	Copper (wt. per sq. ft.)	Galvanized steel <sup>2</sup> (US Std.)	Aluminum (inches)	Corrosion-resisting steel (US Std.)	Terne (US Std.) 40 pound coating weight	Monel (inches)
Cornices and belt courses.....	20 oz	24 gage	0.032	26 gage (.018)	24 gage	0.021
Coping.....	20 oz	24 gage	0.032	26 gage	24 gage	0.021
Corrugated siding.....		26 gage	0.032	26 gage	26 gage	
Drip strip.....	20 oz		0.032	24 gage (.025)		0.021
Edge strip.....	24 oz		0.050	24 gage		
Flashing:						
General.....	16 oz	24 gage	0.032	26 gage	26 gage	0.021
Closed valley.....	16 oz	26 gage	0.032	26 gage	26 gage	0.025
Spandrel beam.....	6 oz <sup>1</sup>			32 gage (.010)		
Smoke pipes and vents		24 gage				
Through-wall.....	16 oz			26 gage		0.018
Gravel stops.....	16 oz	24 gage	0.032	26 gage	26 gage	0.018
Gutter linings.....	20 oz	24 gage		26 gage	24 gage	0.021
Gutters (attached).....	20 oz	26 gage	0.032	26 gage	26 gage	0.021
Gutters (hanging).....	16 oz	26 gage	0.032	26 gage	26 gage	0.018
Hoods and canopies.....	20 oz	26 gage	0.032	26 gage	26 gage	0.021
Leaders (downspouts).....	16 oz	26 gage	0.024	23 gage (.015)	26 gage	0.018
Roof ventilators.....	24 oz	24 gage	0.040	26 gage	24 gage	0.025
Roofing:						
Corrugated.....		22 gage	0.032	24 gage	22 gage	
Batten seam.....	16 oz		0.032	26 gage	26 gage	0.018
Flat seam.....	20 oz			24 gage	24 gage	0.021
Standing seam.....	16 oz		0.032	26 gage	26 gage	0.018
Scuttles.....	16 oz		0.032	26 gage		0.018
Splash pans.....	16 oz		0.040	24 gage		0.021

Note. The above thicknesses are the minimum to be used with the work indicated. Heavier gages should be used when called for by the work or when conditions indicate that the minimum thickness will be unsatisfactory.

<sup>1</sup> Requires coating of plastic bituminous compounds.

<sup>2</sup> Galvanized steel and iron—for use principally on temporary and semipermanent work.

## CHAPTER 12

### FLASHINGS AND APPURTENANCES

---

#### Section I. WALL, CHIMNEY, AND MONITOR FLASHINGS

##### 12.1.1 General Discussion

*12.1.1.1 Function and Usual Causes of Failure.* The function of a flashing is to provide a water-tight junction between the roofing material and other parts of the structure, and between roof sections (fig. 47). Flashings are the most vulnerable part of any roof since the majority of leaks result from failures at these vital areas. There are numerous causes of flashing failures, the most common resulting from inadequate or faulty construction. Many roof and flashing failures could be eliminated by constant and painstaking inspection by competent inspectors during installation. Some common causes of flashing failures are:

- (1) Weathering resulting from insufficient or lack of protective coating.
- (2) Punctures usually resulting from the omission of a cant strip (fig. 48).
- (3) Open laps or seams (fig. 49).
- (4) Separation of flashings from vertical surface.
- (5) No allowance made for expansion and contraction of metal flashings.
- (6) Damage by personnel having access to roofs.

*12.1.1.2 Other Considerations.* In many instances, leaks have been attributed to flashing failures where no such failures were evident. The actual cause may result from open joints in a masonry wall or chimney, into which the water enters, works its way down behind the flashing and into the roofing. In masonry walls, this condition may be eliminated by "through the wall" flashings.

*12.1.1.2.1 Classes.* Flashings may be differentiated into two main classes, namely, base and cap or counter flashing.

(1) *Base Flashing.* The base flashing is the actual junction between the roofing material and the vertical wall, projection, etc., and should be considered as a component part of the roof construction. Metal base flashing is generally used with shingled roofs. The base flashing for built-up

roofing should be of a bituminous nature. Metal base flashing is not recommended for built-up roofs.

(2) *Cap or Counter Flashing.* The cap or counter flashing is usually constructed of metal and serves as a protecting cover for the base flashing. This flashing should extend a minimum of 8 inches and a maximum of 16 inches above the roof line and should be set into a reglet extending into the wall at least 1 1/2 inches. Through-wall flashings are preferred to reglets which extend only part way into the wall. The function of the cap or counter flashing is to protect the base flashing so that all flashing strips and nails are completely covered. In isolated instances, a cap flashing of felt or fabric is employed. This system usually consists of a 4 to 6 inch strip of saturated felt or fabric, embedded in plastic cement and placed 2 to 3 inches above and 2 to 3 inches below the top edge of the base flashing so that all nail heads are completely covered. A uniform coating of a plastic flashing cement is then troweled to a feather edge over the felt or fabric strip. The felt or fabric cap flashing should be frequently inspected as it is more susceptible to weathering than the metal cap flashing. Surface-mounted reglets are available for use on existing walls not having a built-in reglet. The tops of such reglets are generally sealed with an elastomeric sealant.

##### 12.1.2 Flashing Failures

For convenience, the inspection form for flashings is incorporated with the inspection forms for various types of roofing in appendix G.

*12.1.2.1 Base Flashings.* Numerous failures attributed to the roofing material are frequently flashing failures. These areas should be the first to be inspected when leaks in a structure are reported. A good procedure to follow is to first make a careful inspection of the roofing material near the flashings for signs of breaks or of moisture. In built-up roofs, blisters in this area are an indication that moisture has found its way beneath the membrane. When blisters are evident and the mem

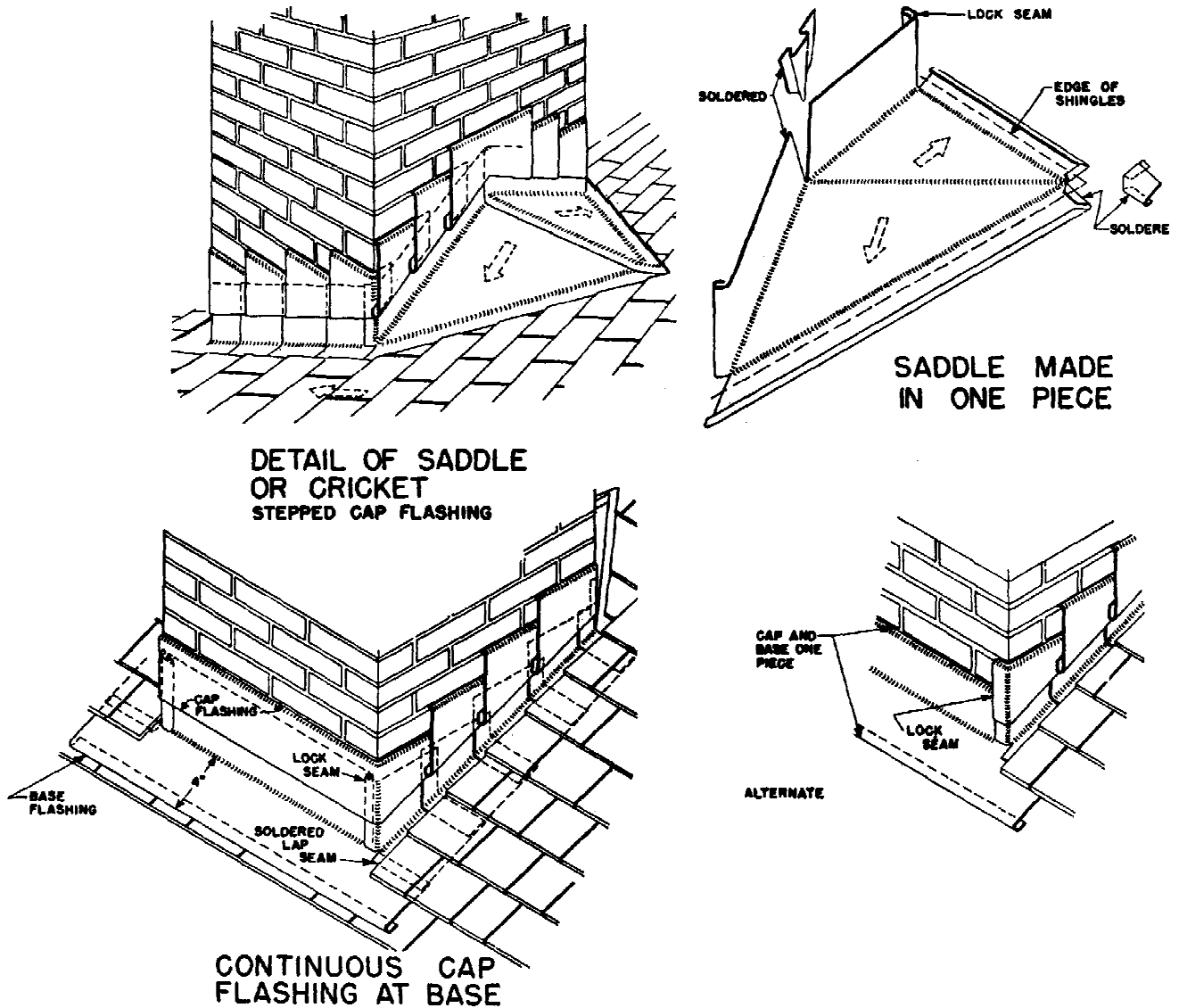

Figure 47. Typical details of chimney flashings.

brane seems intact, a flashing failure is indicated. Punctures, broken laps or seams, separation of flashing from vertical surfaces and deterioration from weather are causes of failure. Flashings that face the sun deteriorate more rapidly. If a cant strip is present, it can usually be detected by gently tapping the flashing with a solid object in the area mid-way between the roof and the vertical surface. The areas in question should be clearly marked for future maintenance and repair.

**12.1.2.2 Metal Base Flashings.** Although the use of metal base flashings in the construction of built-up roofs is not recommended, they are sometimes used. The common failures which occur in a metal base flashing are separation at interface with bituminous materials, cracks, broken joints, and deterioration of ferrous metal flashing due to lack of protective covering. The inspector should pay particular attention to exterior and interior

corners, which areas are most vulnerable. Usually no cant strip is employed when base flashing is of metal.

**12.1.2.3 Bituminous Cap or Counter Flashings.** The most likely causes of failure of bituminous cap flashings are—

- (1) Separation of flashing from the vertical surface and/or from base flashing.
- (2) Deterioration due to lack of protective coating.
- (3) Too heavy application of or use of unsuitable bituminous or plastic cement causing sluffing.

**12.1.2.4 Metal Cap or Counter Flashings.** The common failures in metal cap flashings are—

- (1) Location of the flashing too high or too low above the roof deck.
- (2) Deterioration of ferrous cap flashings resulting from the lack of paint.

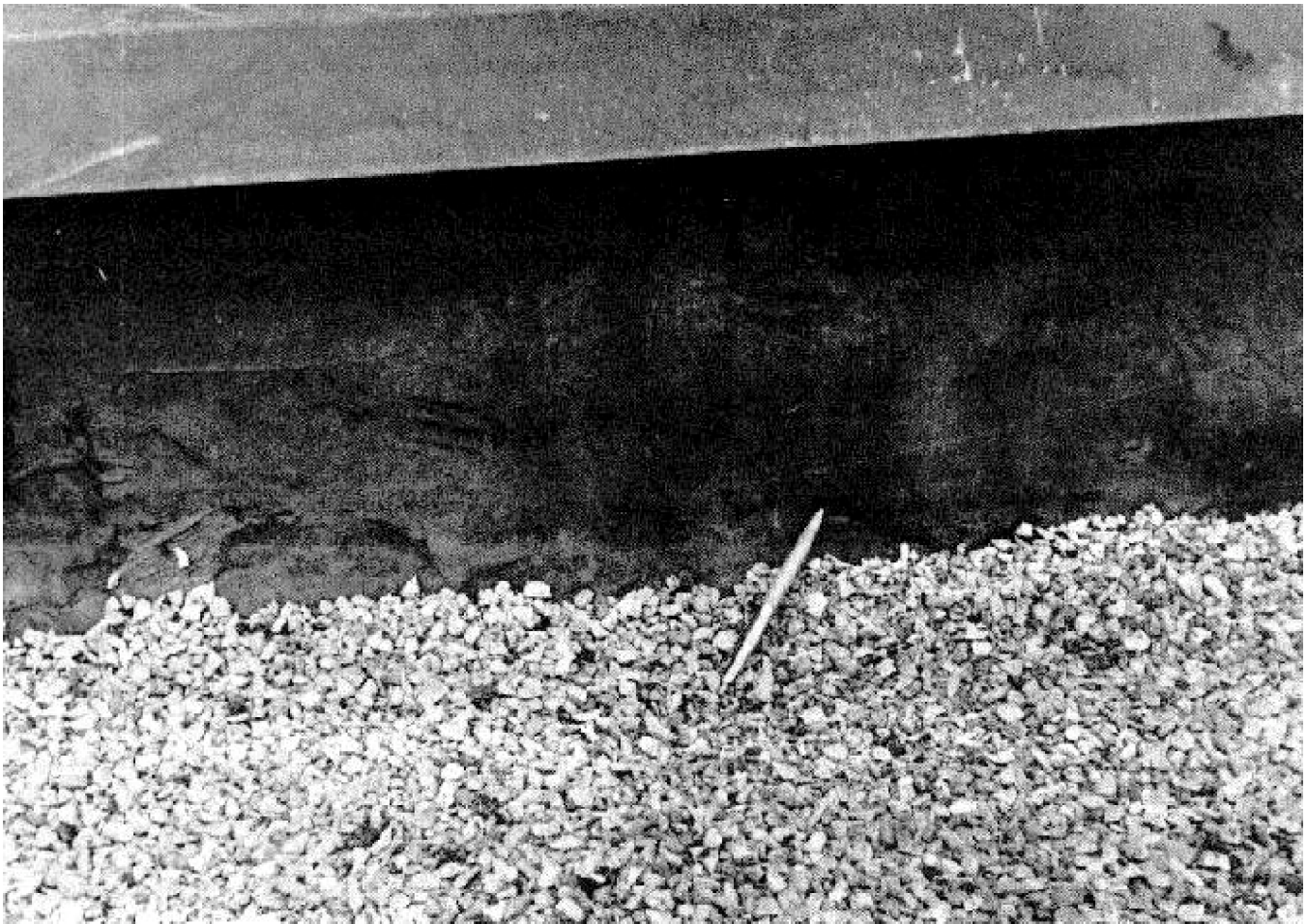

Figure 48. Puncture resulting from lack of cant strip.

- (3) Cracks and broken joints due to expansion and contraction.
- (4) Separation of the flashing from the vertical surface.
- (5) Reglet not sealed.
- (6) Inadequate lap of cap flashing over base flashing permitting entrance of wind-driven rain.
- (7) Cap flashing does not hug tightly to base flashing.

### 12.1.3 Maintenance and Repair Methods

In any discussion of flashings, no distinction can be drawn between maintenance and repair methods. Consequently, the two are combined in this section.

#### 12.1.3.1 Bituminous Base Flashings.

**12.1.3.1.1 Punctures.** Punctures (fig. 48) are usually caused by traffic or by falling objects striking a base flashing where a cant strip has been omitted. For temporary repair, make puncture watertight by coating with asphalt plastic flashing cement, embedding into the cement a saturated felt or fabric, and applying with a trowel a coat of plastic flashing cement. For permanent repair,

remove the broken flashing, install a cant strip and reflash in accordance with standard specifications for new roof construction.

**12.1.3.1.2 Vertical Laps of Flashing Open.** To make repairs when vertical laps of flashing are open, smooth laps back in place and recement with plastic flashing cement. Recoat entire lap with plastic flashing cement.

**12.1.3.1.3 Separation or Sagging of Base Flashing from Wall, Chimney or Monitor.** If separation occurs between the base flashing and a wall, chimney, or monitor, refasten the base flashing to the vertical surface by nailing or cementing. Recoat with a plastic flashing cement and replace appropriate counter flashing.

**12.1.3.1.4 Surface Coating of Plastic Base Flashing Disintegrated.** If the surface coating of a plastic base flashing has disintegrated, brush off all loosely adhering coating and apply a trowel coating of asphalt plastic cement.

#### 12.1.3.2 Metal Base Flashings.

**12.1.3.2.1 Lack of Protective Coating or Paint—Metal Not Severely Deteriorated.** If the



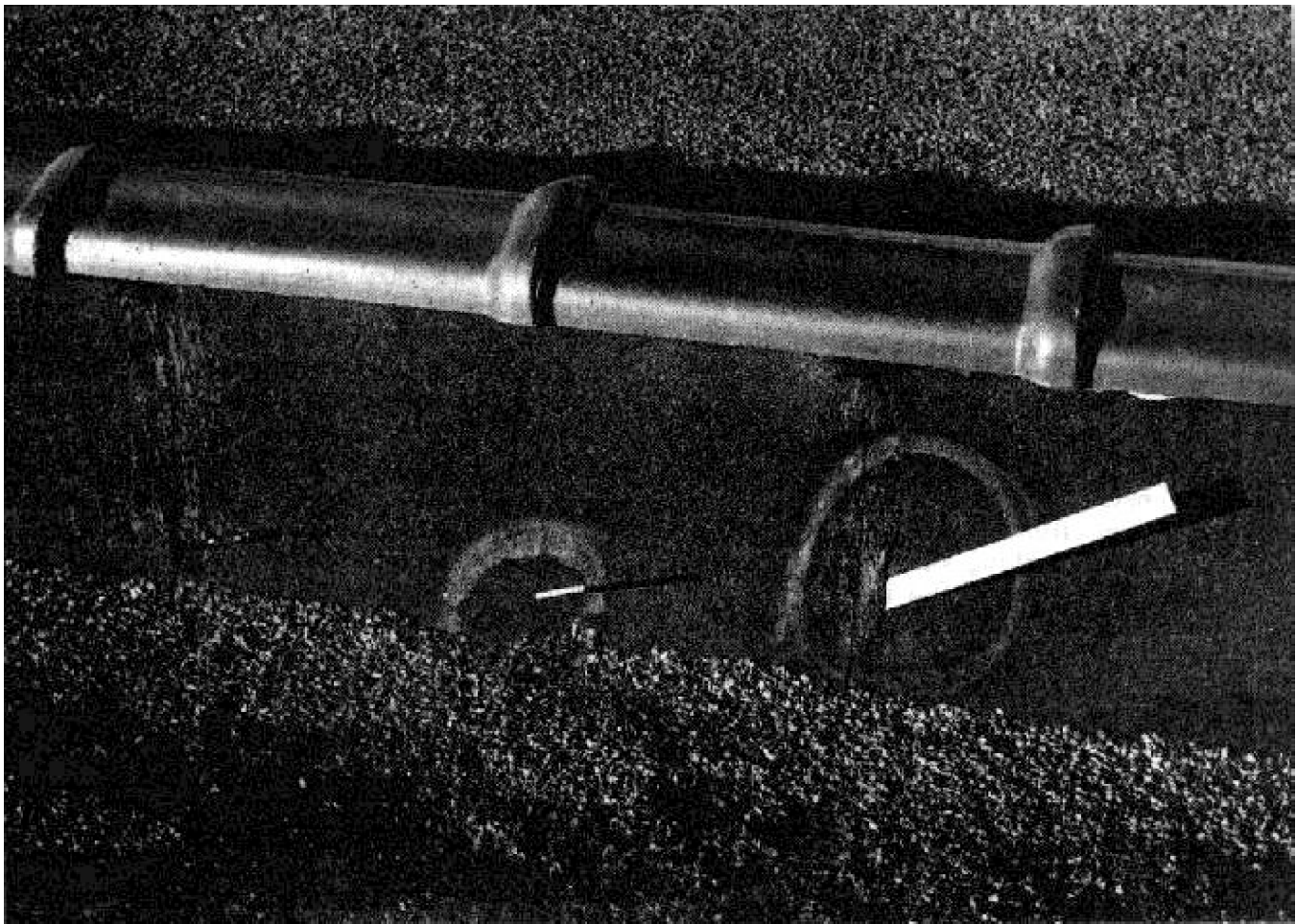

Figure 49. Open laps and split in base flashing..

protective coating of paint on metal base flashing has deteriorated but the metal itself is not severely damaged, remove all rust, moisture, loose scale, grease, dirt, etc., and apply fresh coating of paint. Instructions for painting metal are given in the tri-services paint manual.

*12.1.3.2.2 Lack of Protective Coating Of Paint—Metal Severely Deteriorated i.e., Holes, Punctures.* If the metal has deteriorated to the extent that there are holes or punctures, remove and discard deteriorated area of flashings and replace in kind. If membrane is being replaced, provide cant strips and use bituminous base flashing in lieu of metal base flashings.

*12.1.3.2.3 Vertical Joints of Base Flashing Open.* When the vertical joints of metal base flashings are open, straighten the metal flashing and put it in place. Resolder open joints. Install additional expansion joints where necessary.

*12.1.3.2.4 Separation of Metal Base Flashing from Wall, Chimney or Monitor.* If metal base flashing is separated from wall, chimney, or monitor, treat as described under maintenance and repair of plastic base flashings, paragraph 12.1.3.1.3.

*12.1.3.3 Bituminous Cap or Counter Flashings.*

*12.1.3.3.1 Separation of Bituminous Cap Flashing from Vertical Wall and/or Base Flashing.* If a separation occurs between the cap flashing and the vertical wall and/or the base flashing, recement the cap flashing with a plastic flashing cement and apply a trowel coat of flashing cement.

*12.1.3.3.2 Deterioration Caused by Lack of Protective Coating.* If the cap or counter flashing has deteriorated owing to the absence of a protective coating, brush off all loosely adhering coating and apply a trowel coating of plastic flashing cement.

*12.1.3.4 Metal Cap Flashings.*

*12.1.3.4.1 Lack of Protective Coating of Paint—Metal Not Severely Deteriorated.* If the protective coating of paint on metal cap flashings has deteriorated but the material itself is not severely damaged, remove all rust, moisture, loose scale, grease, and dirt and apply a fresh coating of paint. Instructions for painting are given in the tri-services paint manual.

12.1.3.4.2 *Lack of Protective Coating of Paint—Metal Severely Deteriorated.* If the metal cap flashings are deteriorated to the extent that there are holes or punctures, remove and discard the deteriorated area of flashings and reflash in accordance with standard specifications for new construction.

12.1.3.4.3 *Metal Cap Flashing Located Too High or Too Low to Function Properly.* When the metal cap flashing is located too high or too low to function properly, remove the loose flashing and trim off flush with the wall any flashing metal left in the joint. Make necessary repairs to the vertical surface and reflash in accordance with standard specifications for new roof construction. Provide new reglets as required. Where bituminous base flashings are provided, the cap flashing should extend down as close as practicable to the top of the cant strip. Where metal base flashings are provided, the cap flashing should overlap the metal base flashing at least 3 inches.

12.1.3.5 *Repair Methods of Flashings When Repairs Involve Application of a New Membrane.* If the existing roofing membrane is to be replaced, base flashings and cap or counter flashings should be removed. An exception may be made with the metal counter flashing that is in good condition, well fastened to the wall, and which will stand bending up for the application of new base flashing and bending down after base flashing is installed. Install new base flashing after repair membrane is applied in accordance with standard specifications for new roof construction. Install cant strips at

intersection of roof with vertical surfaces. Cant strips should be attached to the deck and not to the wall. Replace metal base flashings with bituminous base flashings.

12.1.3.6 *Repair Methods for Parapet Walls.* It is poor practice to coat parapet or fire walls with an impervious coating. Moisture trapped within the masonry may result in spalling or deterioration.

12.1.3.6.1 *Mortar Joints Deteriorated.* To repair deteriorated mortar joints, rake out all loose mortar and repoint with a 1:1:6, portland cement, hydrated lime and sand mortar, proportioned by volume.

12.1.3.6.2 *Joints in Coping Open.* To repair open joints in the coping, rake out all loose material and repoint with portland cement or a suitable caulking compound.

## 12.1.4 Reroofing

When preparing projects for reroofing, careful attention must be given to the flashing design. Flashings must be fully detailed on the contract drawings. In recent years, many improved flashing designs and practices have been developed, particularly as regards built-up roofing. The reroofing project should incorporate the best flashing design possible. Well designed flashings properly installed will hold future maintenance and repair to a minimum. Much useful information on flashing can be found in the publications listed in appendix E.

## Section II. VENT FLASHINGS (VENTILATORS, PLUMBING STACKS, ETC.)

### 12.2.1 General Discussion

The majority of vents are constructed of metal and consequently are subject to expansion and contraction. For this reason, it is poor practice to attempt to flash up the sides of such projections as this type of flashing is subject to early failure. Vents are usually of two types, the flat flange vent and the curb vent. The curb vent is the preferred type. The flat flange vent is placed directly upon the last ply of roofing while the curb vent is constructed to fit over a wooden or concrete curb. Each type is supplied with a component flashing flange by which the vent is connected to the roofing. In the case of the flange vent, asphalt plastic cement is used generously beneath and above the metal flashing flange which is securely nailed to the roof. The flange is stripped with two plies of felt, not less than double the width of the flange, cemented solidly together and to the flashing flange with asphalt, pitch or plastic cement. In the case of the

curb vent, the base flashing is brought up and over the curb.

### 12.2.2 Failure—Vent Flashings

All vents and vent flashings should be carefully inspected during the periodic roof inspection and at such times that leaks are reported in the structure. An inspection should also be made from the underside of the roof. Damp areas or stains near the vent indicate a flashing failure, the common causes being:

- (1) Broken seams caused by expansion and contraction.
- (2) Exposed nails that have worked loose causing separation of metal flashing flange from roof (fig. 50).
- (3) Omission of felt stripping over edge of flange.
- (4) Standing water around vent.

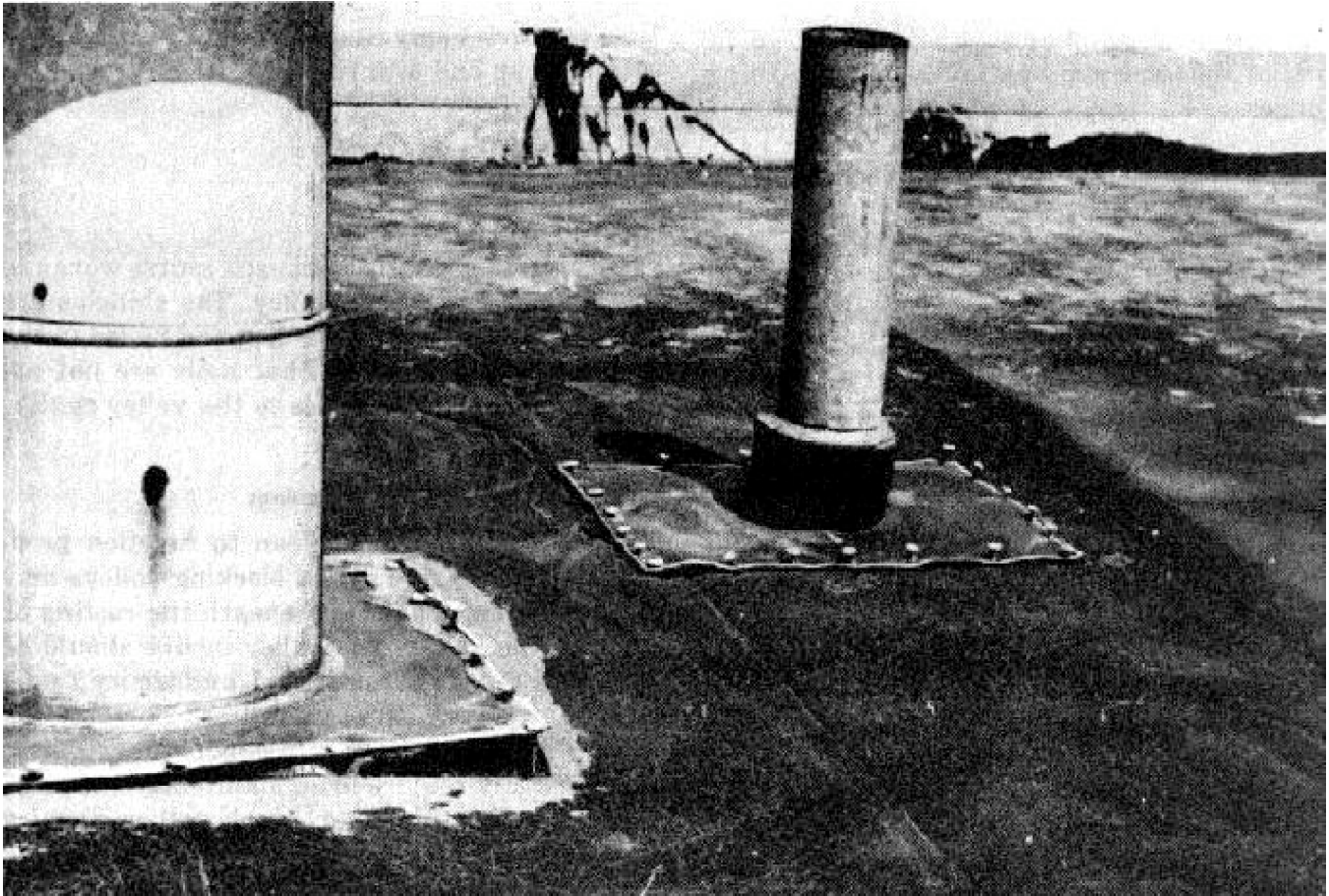

Figure 50. Improper installation of vent and stack flashings.

(5) Deterioration of metal caused by lack of a protective coating of paint.

### 12.2.3 Maintenance of Vent Flashings

12.2.3.1 Broken Seams Caused by Expansion and Contraction. When broken seams occur as a result of expansion and contraction, resolder broken seams and install additional expansion joints if necessary.

12.2.3.2 Separation of Flashing Flange From Roof Caused by Exposed Nails Working Loose. When exposed nails that hold a roofing flange to a roof work loose, raise flashing flange high enough to force plastic cement beneath it and redrive loose nails. Apply two piles of felt or fabric cemented to each other and to the flange and roofing membrane with asphalt, pitch, or plastic cement. The outer edge of the first ply of felt or fabric should extend not less than 3 inches beyond the flange and of the second ply of felt or fabric not less than 6 inches. Apply finished surfacing similar to roof surfacing.

12.2.3.3 Omission of Felt Stripping Over Flashing Flange. When the felt stripping over a flashing flange is omitted, treat edges by applying two layers of felt or fabric as described in preceding paragraph.

12.2.3.4 Standing Water Around Vent or Water Stains on Adjacent Roofing. (Treat only if leakage occurs). Remove old flashing and reflash in accordance with instruction given in paragraph 12.2.3.2 above. In severe cases reinstallation of the vent may be called for.

12.2.3.5 Lack of Protective Coating of Paint With or Without Deterioration of Metal. When the metal surface is not protected by paint, remove all rust, moisture, loose scale, grease, dirt, etc., and apply fresh application of paint. Instructions for painting metals are given in the tn-services paint manual. In cases where the metal is seriously deteriorated, removal and replacement with a new vent may be called for.

### 12.2.4 Repair of Metal Vents During Reroofing

When reroofing, metal vents and the flashing flanges should be carefully inspected for signs of deterioration. If deterioration is serious, remove old vent and install new vent in accordance with standard specifications for new roof construction. When the existing vent is deemed serviceable, proceed as follows:

(1) *Flange Vent.* If possible, remove the vent and reset on top of new membrane. If the flashing

flange is securely fastened to the old roof, the new membrane should be cut to fit around the vent and applied over the flashing flange.

(2) *Curb Vents*. Raise the vent. Install new flashing up and over the curb. Refasten vent to the curb.

## Section III. VALLEY FLASHINGS

### 12.3.1 General Discussion

Roof valleys are formed when two sloping roof sections join to form a V. Since water from both sections is concentrated in the valley, valleys are of extreme importance. Valley flashings on tile, slate, asbestos-cement shingles, wood shingles, metal and similar roofs are usually constructed of metal. Valley flashings for asphalt strip shingles may be metal type, mineral-surfaced asphalt roll roofing type, or woven asphalt strip shingles type. Valley flashings on mineral-surfaced asphalt roll roofing are constructed either of metal or mineral-surfaced roll roofing.

*12.3.1.1 Metal Valley Flashings*. Metal valley flashings may be of 20-ounce copper or similar material and are applied in sheets not exceeding 8 feet in length, free from longitudinal seams and of sufficient width to extend not less than 4 inches under the roof covering on each side. The exposed portion is approximately 4 inches wide at the top and increases 1 inch in width for each additional 8 feet in length. Each section is lapped not less than 6 inches (8 inches where the slope of the valley is less than 4½ inches per foot) in the direction of flow and the upper end is fastened to the roof deck. With slate or tile roofing, 24-ounce copper is generally used in place of the 20-ounce, and where valleys are installed with clay or cement tiles, the exposed valleys have a uniform width of 4 inches in place of the increasing width of 1 inch per 8 feet.

*12.3.1.2 Mineral-Surfaced Asphalt Roll Roofing Valley Flashings*. Mineral-surfaced asphalt roll roofing is satisfactory for flashing valleys of both asphalt-shingle and mineral-surfaced asphalt roll roofing roofs. The valley is lined with two thicknesses of the material. The first ply is 18 inches in width and centered in the valley with surfaced side down. The second ply, 36 inches in width, is applied over the first strip, centered into the valley, nailed and cemented with surfaced side up. The width of the valley is 6 to 8 inches wide at the top and will diverge at the rate of 1 inch per each 8 feet of the valley.

*12.3.1.3 Woven Asphalt Strip Shingle Valley Flashings*. In this type valley flashing, the full length of the valley is first lined with smooth-surfaced roll roofing 36 inches wide. The asphalt strip shingles are then applied on both roofs simultaneously with each course woven in turn to form a closed valley. The shingles are pressed

tightly into the valley and nailed in the normal manner except that nails are not applied closer than 6 inches to the valley center-line.

### 12.3.2 Failure of Valley Flashings

Valleys must be kept clean to function properly. Ice dams and debris blocking valleys may cause water to back up beneath the roofing of laps of the valley. The valley incline should be checked for smoothness and uniformity to assure a rapid run-off of the water.

*12.3.2.1 Metal Valleys*. Copper valley flashings usually require little maintenance if properly installed. However, terne valleys require protective paint coatings, and galvanized iron should be painted when the first signs of rust appear. Separations at the end laps and openings in the metal resulting from corrosion are common failures.

*12.3.2.2 Mineral-Surfaced Roll Roofing Valley Flashings*. The inspector should look for signs of normal weathering which will most likely appear in this area first since water concentrates in the valley. The first indication is the loss of granules, slight at first, but accelerating as the loss of granules exposes more of the asphalt to the weather. Separation of end laps and separation of the roof propel from the valley flashings often result in leaks.

### 12.3.3 Maintenance and Repair

*12.3.3.1 Metal Valley Flashings*. Valleys must be kept clean to function properly.

*12.3.3.1.1 Leakage Occurring at Laps*. Do not attempt to solder laps. Treat seams or lap with a white lead paste consisting of basic lead carbonate and 8 percent boiled linseed oil.

*12.3.3.1.2 Small Holes in Copper Flashings*. Clean surface around hole with emery cloth, apply a flux of zinc chloride or resin and repair with a drop of solder.

*12.3.3.1.3 Large Holes in Copper Flashings*. Prepare surface as in paragraph 12.3.3.1.2 above and solder a piece of copper over the hole.

*12.3.3.1.4 Holes in Galvanized Metal Flashings*. Replace the smallest unit of the flashing.

*12.3.3.1.5 Lack of Protective Coating of Paint on Terne or Galvanized Metal Valleys*. Painting should never be put off until rust appears.

Should rust appear, remove all rust, moisture, loose scale, grease, dirt, etc., and apply new application of paint. Instructions for painting metals are given in the tn-services paint manual.

*12.3.3.2 Mineral-Surfaced Roll Roofing Valley Flashings.* Valley must be kept clean to function properly.

*12.3.3.2.1 Loss of Granules Due to Normal Weathering and Water Concentrating in Valley.* Remove all loose granules, dust, and dirt by sweeping, vacuuming or air blast and apply one thin coat, by brushing, of asphalt primer (55- A-701). After primer is dry, apply one of the following:

(1) A coating of asphalt emulsion (MIL-R-3472) by brush at a rate of 3 gallons per square.

(2) Asphalt base roof coating meeting Federal Specification SS-A-0694C, by brush, at a rate of 3 gallons per square.

*12.3.3.2.2 Separation of End Laps.* When end laps of roll roofing valley flashings have separated, lift upper lap high enough to force a liberal amount of plastic cement between plies and press top lap firmly in place.

*12.3.3.2.3 Separation of Roofing or Shingles from Flashing.* Gently lift separated shingle or area, force plastic cement beneath it, and press shingle or roofing firmly into the cement.

## Section IV. DRAINAGE SYSTEMS

### 12.4.1 General Discussion

The drainage system includes all gutters, leaders, drains, scuppers, crickets, etc. The primary function of this system is to remove water from a roof as quickly as possible and to prevent the storage of water on the roof. Every roof must have

some provision for drainage, including the so-called "dead level" decks. It is important that drainage areas be kept free from debris which will interfere with proper drainage (fig. 51). Many roof failures can be traced both directly and indirectly to

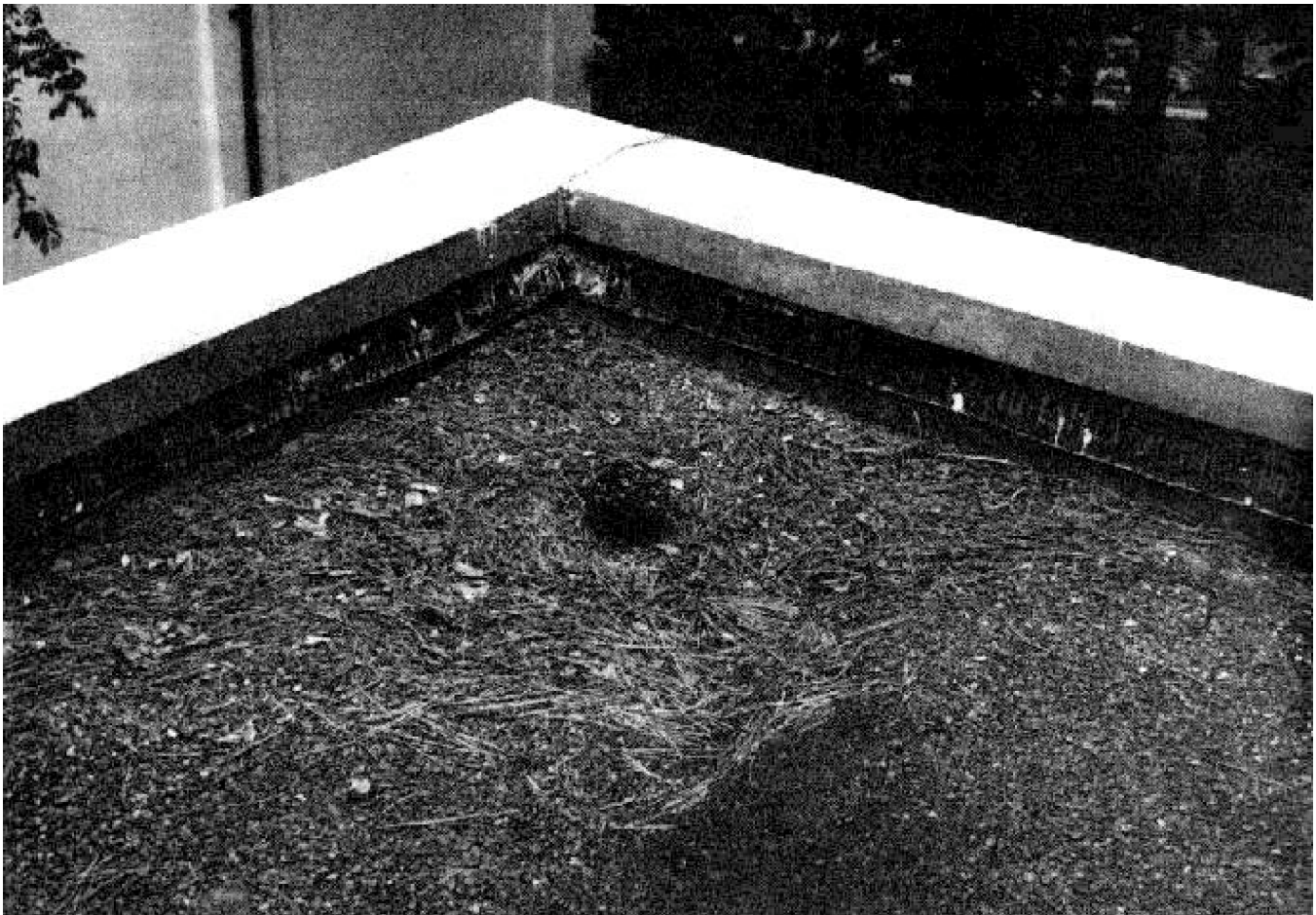

*Figure 51. Debris on roof impedes drainage.*

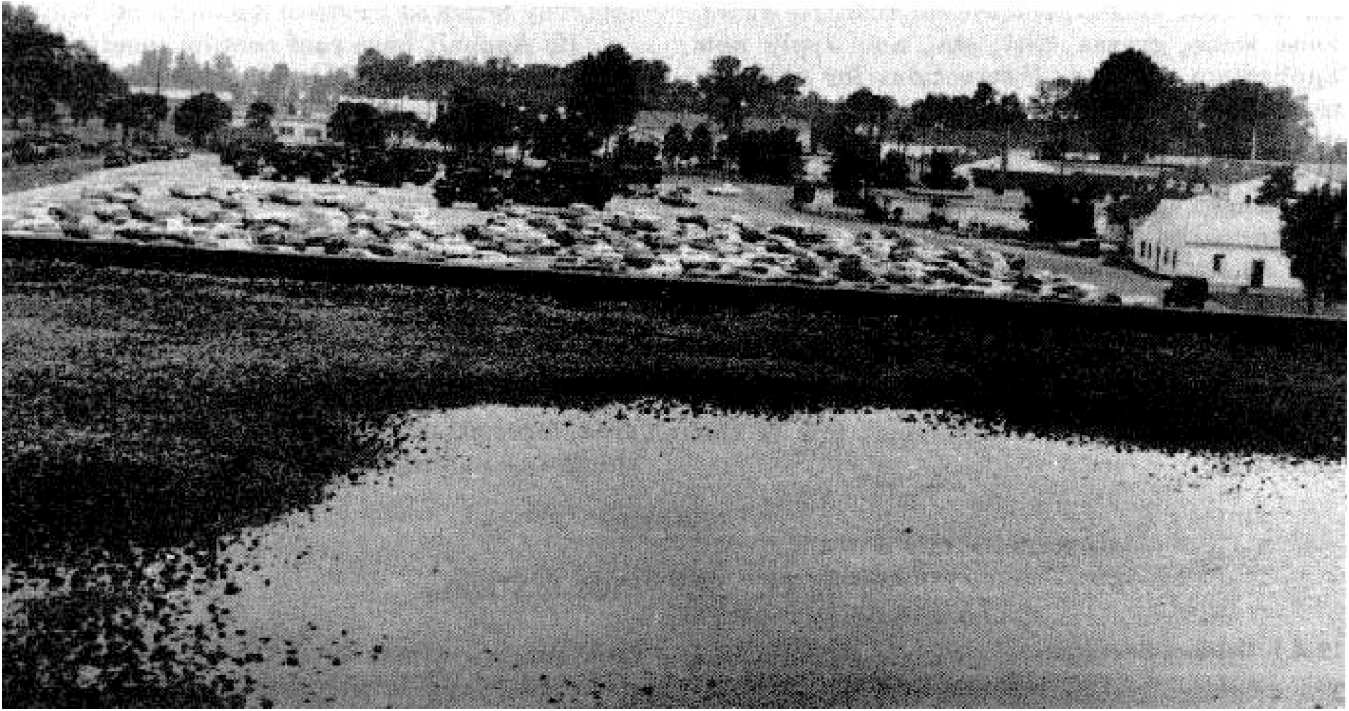

*Figure 52. Drain not located in low area — ponding sometimes caused by structural defect.*

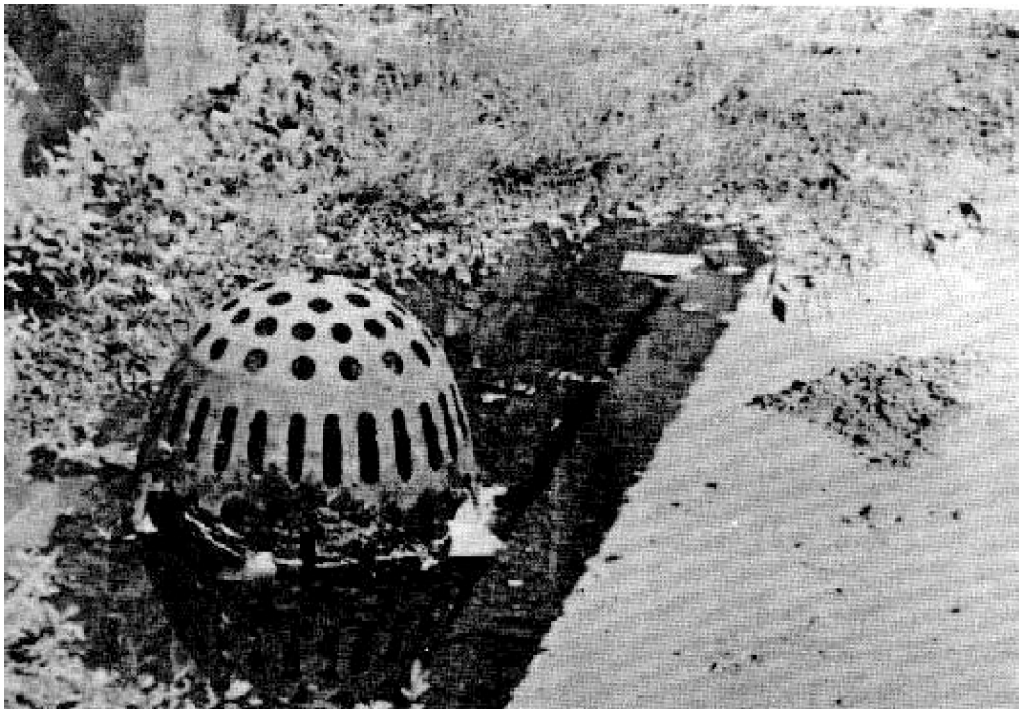

*Figure 53. Clogged drains — drains must be kept clean to function properly.*

inadequately designed or improperly installed drainage systems. Ponded water (fig. 52) may indicate structural defects.

#### **12.4.2 Inspection**

A suggested checklist for inspectors is as follows:

(1) Check deck incline. It should be smooth and uniform.

(2) Look for low areas. Standing water or water stains are signs of low areas.

(3) Check gutters, leaders, etc., for obstructions which will hinder the run-off of water.

(4) Check size, locations and number of drains, gutters and leaders.

(5) Look for broken or clogged drains.

(6) Look for standing water around drains.

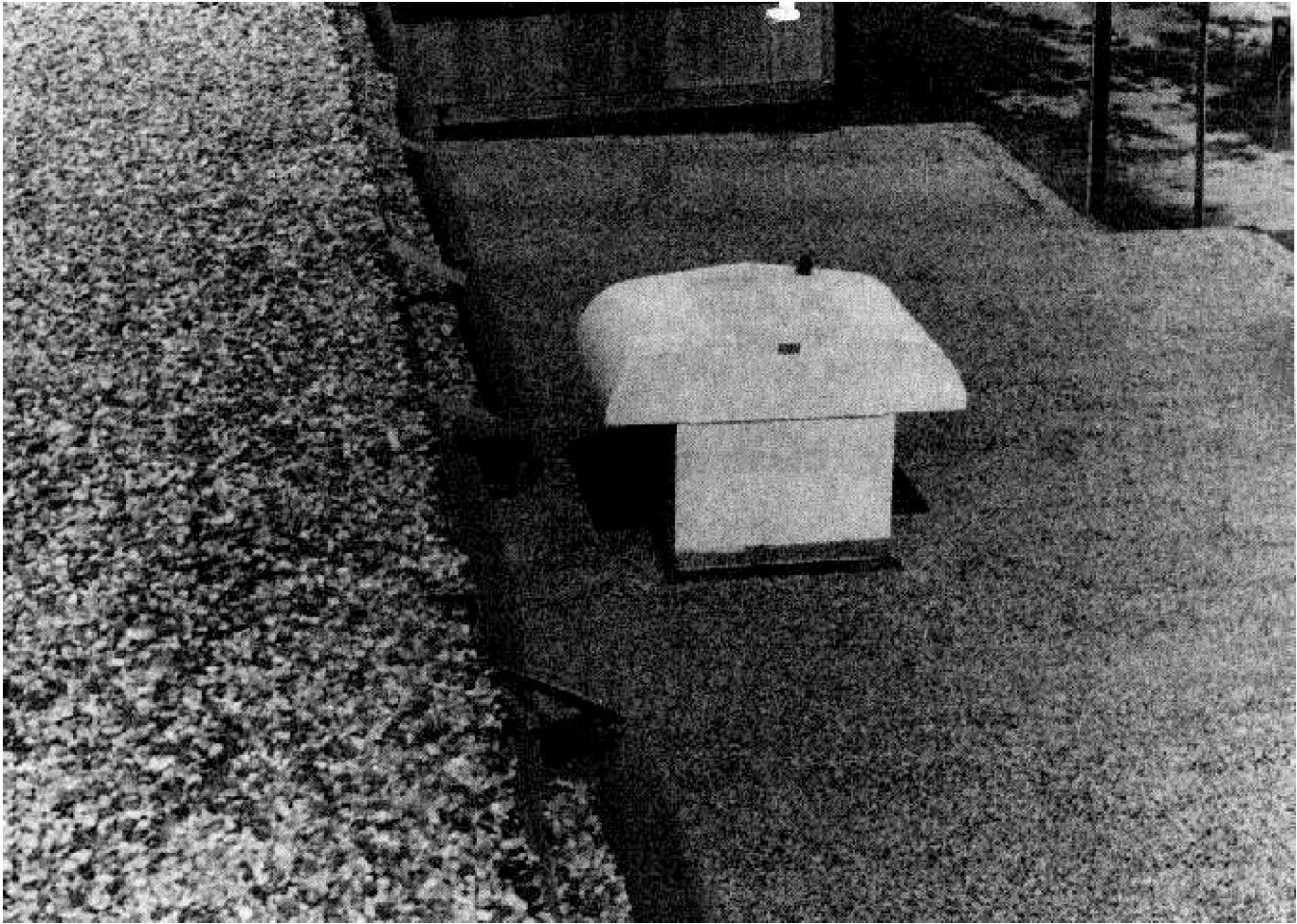

Figure 54. Accumulation of gravel causing collapse of gutter.

This indicates drain is set too high or not in correct location.

(7) Look for defective flashing around drains. Drains are usually equipped with a flashing flange which should be securely fastened to the roof deck and double felt stripped as in the case of vent flashings.

(8) Check gutters for defective hangars and straps. Check gutter for slope. Gutters should slope downward to the leader a minimum of 1/16 inch per foot of length.

(9) Check gutters for holes, rust, or other signs of deterioration.

### 12.4.3 Maintenance and Repair

*12.4.3.1 Drains.* Roof drains must be kept clean to function properly (fig. 53).

*12.4.3.1.1 Broken Drains.* Remove broken drain and install new drain in accordance with specifications for new roof construction.

*12.4.3.1.2 Separation of Flashing Flange from Roof.* If flashing flange is separated from roof, treat as described in paragraph 12.2.3.2.

*12.4.3.1.3 Standing Water Around Drain.* If

drain is not clogged, standing water (so-called "bird baths") indicates drain is not at a low point of the area or is set too high. The drain should be lowered or relocated at a low point of the area.

*12.4.3.2 Gutters and Leaders.* Gutters and leaders must be kept clean to function properly. Remove all gravel, slag, dirt, leaves, or other debris (fig. 54).

*12.4.3.2.1 Rusting or Corrosion of Gutters and Leaders.*

(1) Metal not deteriorated: Remove all rust, moisture, loose scale, grease, dirt, etc., and apply new coat of paint. Instruction for painting metals are given in the tn-service paint manual. Inside surfaces of gutters may be painted with asphalt varnish.

(2) Metal severely deteriorated: Remove defective section and replace with new material in accordance with standard specifications for new roof construction.

*12.4.3.2.2 Defective Straps and Hangers.* Defective straps and hangers should be replaced and/or realigned. Add new hangers or redesign hangers as required.

12.4.3.2.3 *Gutters Overflowing.* The engineer should check size and slope of gutters, and number and size of leaders for adequacy. If gutters and leaders are found deficient in capacity to carry off anticipated run-off, they should be replaced using increased sizes and slopes.

12.4.3.3 *Low Areas, Permitting Water to Stand (fig. 52).* Failures of this type are usually the result of poor design or structural failure. Building up the roof covering with felt and hot bitumen or any type of fill is not generally recommended since the

materials only add weight to an already weakened area. Before repair or reroofing is started, the low area may sometimes be corrected by raising the sunken joists or installing new joists. Where raising joists or purlins is impractical, the placing of additional drains in the low area will serve to remove the weight of ponded water from the roof and lessen deterioration of the roofing membrane. Such would be the case where wood trusses, purlins, or other structural members have sagged.

## Section V. GRAVEL STOPS AND METAL EDGING

### 12.5.1 General Discussion

The primary function of gravel stops (slag or gravel surfaced roofs) and metal edging (smooth-surfaced built-up roofs) is to finish off all exposed edges and eaves in order to prevent wind from getting under the edges causing blow-offs. Another important function of the gravel stop is to prevent the loss of gravel, slag, or bitumen from areas near the edge of the roof. The flashing flange of the gravel stop or edge strip is placed over the last ply of felt and should extend at least 4 inches on the roof. It should be embedded in roofing cement, nailed securely to the roof deck, and double felt stripped, after which the finished coat of bitumen and surfacing or cap sheet is applied. The lip of the gravel stop should protrude a minimum of  $\frac{3}{4}$  inch above the roof deck while the lip of the metal edging should be a maximum of  $\frac{1}{2}$  inch above the deck. Both should be securely fastened to the fascia board. Many structures have been observed where gravel stops or metal edging have been omitted. In lieu of this practice, the roofing membrane was bent over the edge and fastened to the fascia board with wooden battens. Numerous failures or potential failures have occurred at these vital areas due to severe weathering of the roofing materials and to the deterioration of the wood battens and the fascia boards which in turn renders the roof membrane susceptible to wind damage.

### 12.5.2 Inspection

The gravel stops and metal edging should be inspected during the annual inspection of the roof. The inspector should examine carefully the entire edge of the roof, paying particular attention to:

- (1) Deteriorated gravel stops and metal edging (fig. 55).
- (2) Damaged or rotted overhangs and fascia boards.

(3) Separation of flashing flange from the roof.

(4) Bitumen flowing under gravel stop and down fascia board.

(5) Omission of gravel stops and metal edging.

### 12.5.3 Maintenance and Repair

12.5.3.1 *Deteriorated Gravel Stops and Metal Edging.*

12.5.3.1.1 *Not Seriously Deteriorated.* Remove all rust, moisture, loose scale, grease, dirt, etc., and apply fresh coating of paint to ferrous metal. Instructions for painting ferrous metals are given in the tri-services paint manual.

12.5.3.1.2 *Seriously Deteriorated.* Remove and discard section containing deteriorated area and replace in accordance with standard specifications for new roof construction. Replace damaged overhang and fascia boards as required.

12.5.3.2 *Damaged, Rotten or Deteriorated Fascia Boards and/or Overhangs.* Remove and discard all deteriorated metal. Replace deteriorated fascia boards and overhangs and install new gravel stop or metal edging in accordance with standard specifications for new roof construction.

12.5.3.3 *Separation of Flashing Flange from Roof Membrane.* When the flashing flange is separated from the roof membrane, scrape off gravel or slag at least 12 inches from gravel stop and lift flange high enough to force plastic cement beneath it. Renail in place on 3-inch centers and apply two layers of felt stripping, embedded in hot asphalt, the top one overlapping the lower one 2 to 3 inches. Pour hot bitumen over bare area and while hot, embed clean, dry slag or gravel as used for the roof.

12.5.3.4 *Bitumen Flowing Beneath Gravel Stop and Down Fascia Boards.* This type of failure, more



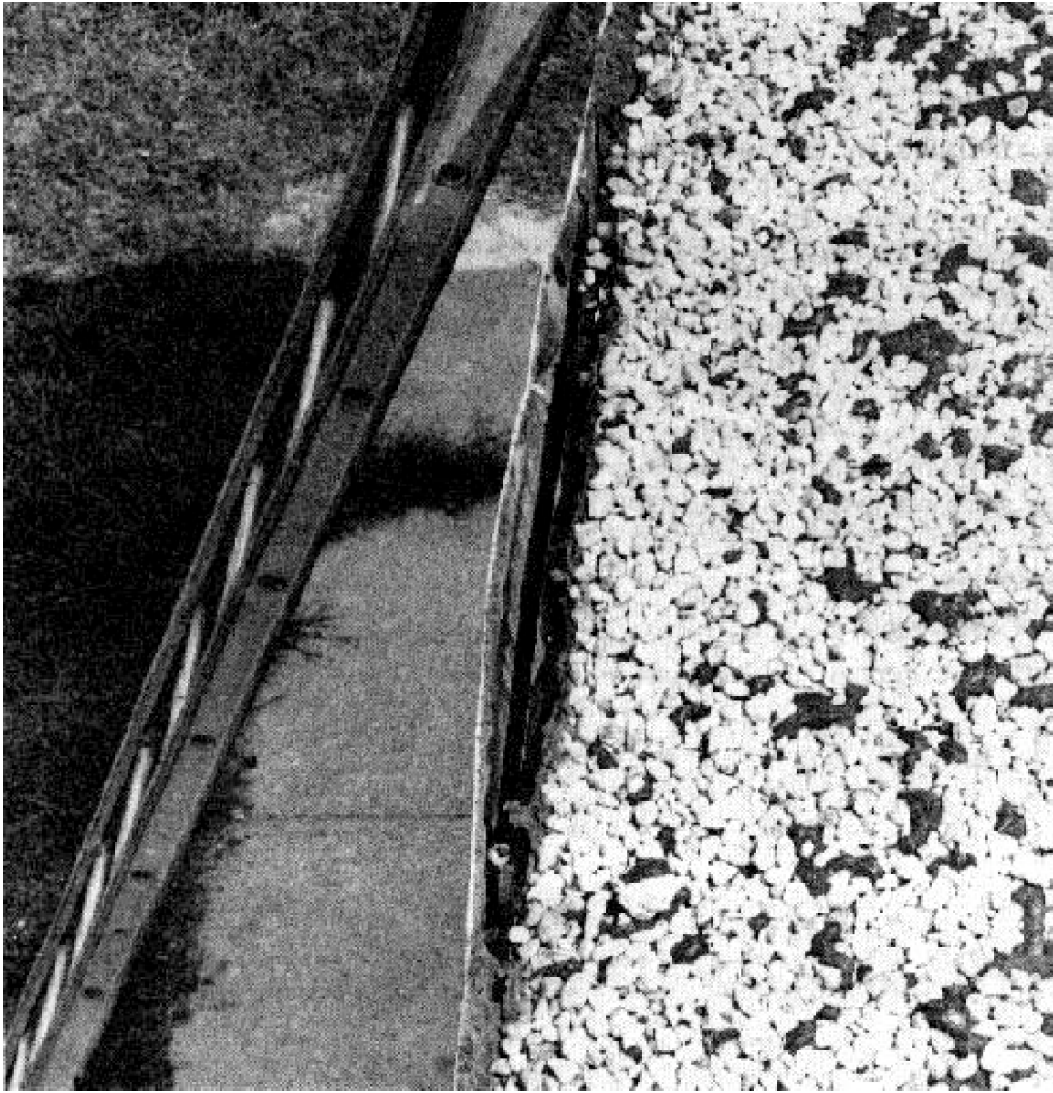

Figure 55. Deteriorated gravel stop.

common in the coal-tar pitch roof, is usually due to original design or construction and very little can be done to correct it after installation of the roof. However, it can be prevented by a simple means, by installing the roof as follows:

(1) Extend the first two plies of felt at least 6 inches beyond the edge of the roof.

(2) Cut the next 2 or 3 plies even with the edge.

(3) Turn the extension of the first two plies back and over the other plies forming an envelope.

(4) Install gravel stop in usual manner over this. Modifications of the above method or metal bitumen stops may also be used.

*12.5.3.5 Omission of Metal Gravel Stop or Metal Edging.* Areas where metal gravel stops and metal edging have been omitted should be inspected at frequent intervals (every 6 months) and at first indication of failure, gravel stops or metal edging should be installed in accordance with standard specifications for new roof construction. This will prevent costly blow-offs.

## Section VI. OTHER PROJECTIONS

### 12.6.1 General Discussion

The projections included in this section are pipes, ladder struts, flag poles, bracings for signs, etc., which penetrate the roofing. No attempt should be made to flash around these projections with felts, as any expansion, contraction or other movement in these members will crack the felts and a leak will develop. On shingle-type roofings such projections should be flashed with a metal sleeve flashing with flange. On built-up roofs curb-type flashing is recommended for such projections. While pitch pockets are also used, their use should be avoided where possible.

### 12.6.2 Maintenance and Repair

To repair old felt flashings at projections, cut away

the felt flashings and install a curb-type flashing, a metal sleeve flashing with flange, or a pitch pocket with flange. The flashing flange should be placed on the last ply of felt and securely nailed and cemented to it. The flange then should be stripped with two layers of felt, the top one overlapping the bottom one by 2 to 3 inches, and cemented with hot bitumen. In the case of the pitch pocket, the cup is fitted with hot bitumen. On wood decks, a layer of concrete, 1 inch in thickness, is poured in the pitch pocket and allowed to set prior to filling with the hot bitumen.

### 1 2.6.3 Reroofing

In reroofing, curb-type flashings should be provided to the extent feasible.

## CHAPTER 13

### SPECIAL ROOFINGS

---

#### Section I. ELASTOMERIC ROOFING

##### 13.1.1 Description and General Discussion

Elastomeric roofing is a comparatively recent development which is being increasingly used for special applications. There are two types, namely the fluid applied system and the sheet applied system. The fluid applied system is comprised of multiple coats of elastomeric materials applied to suitable, dry, smooth substrates. The sheet applied system involves application of elastic sheet material directly to the deck or to a coated base sheet with either hot asphalt or manufacturer's adhesive.

##### 13.1.2 Use of Elastomeric Roofing

An advantage of elastomeric roofing is that it may be readily applied to roofs or surfaces with irregular or warped shapes on which it is not

feasible to use conventional roofing materials. Elastomeric roofing is also light in weight and is reflective. However, because of the high cost and the limited experience factor, the use of elastomeric roofing on military structures must be fully justified. Elastomeric roofing must be applied only by experienced personnel and strictly in accordance with the manufacturer's instruction. Compatibility of the fluid applied elastomeric roofings with the existing surface must be verified. In repair work, elastomeric roofing may sometimes be used to advantage in problem areas where other roofings or methods have proved unsatisfactory or impractical, and additional cost can be justified. Military guide specifications covering the installation of elastomeric roofing are available.

#### Section II. BARE CONCRETE ROOFS — TROPICAL AREAS

Exposed concrete slabs have, by themselves, performed satisfactorily as roofings in the tropics. A major area of concern in such roofs is the proper treatment of joints and cracks. In the case of the precast roofing, it is the treatment of interpanel joints; in the case of the poured-in-place concrete slabs, it is the treatment of construction joints and cracks which occur as the result of shrinkage, thermal or structural movement, etc. Experience indicates that cracks and joints may be effectively waterproofed by covering the crack or joint with a reinforcing fabric embedded in a suitable bituminous material such as roofing cement. A "bondbreaker" consisting of a 2-inch wide strip of plastic sheeting, paper, or other material, should be

placed dry over the crack or joint to prevent a stress concentration at that point. Joint sealants (such as TT-S-227 or TT-S-230 show promise for panel joints. Concrete surfaces to be in contact with the sealant must be clean. A "bondbreaker" should be placed at the base of the joint to insure a proper shape factor (ratio of width of joint to thickness of sealant). For a discussion of "shape factor" see Department of the Army TM 5-805-6 (Department of the Air Force AFM 88-4, Chapter 4), November 1965, entitled "Calking and Sealing." If the number of cracks and joints in a concrete roof deck become excessive and maintenance becomes uneconomical, it will be necessary to apply a membrane type roofing.

#### Section III. ROOFING IN ARCTIC AREAS

##### 13.3.1 General

The low temperatures experienced in arctic areas for prolonged periods cause problems with roofing. Application of roofing, particularly built-up types, is difficult and can only be accomplished during the

summer months. The low temperatures affect the roofing itself. Perhaps the greatest problem is that caused by the temperature differential between the interior and exterior of the building. This difference can be 120°F or more when outside temperatures reach -40° to -75° F. With this temperature

difference moisture vapor tends to migrate to the outside (lower temperature), and will condense and freeze within the roof construction (insulations) if precautions are not taken. The temperature differential between summer and winter, resulting in contraction or expansion of the roofing membrane, also constitutes a problem.

### **13.3.2 Vapor Barrier**

The provision of an adequate vapor barrier is of vital importance in roof construction in the arctic. The vapor barrier must be applied on the warm (room side), be of low permeance to restrict the flow of water vapor, and be continuous. It is preferable that the vapor barrier and insulation be placed below the roof deck rather than between the roofing and the deck. Lack of a vapor barrier will result in a buildup of ice within the roof construction and lead to premature failure.

### **13.3.3 Roof Slope**

Positive drainage should be provided for roofs in arctic areas. Built-up roof should have a slope of at least 1 inch per foot. For roofs of limited width, repair measures may include the provision of a new sloped deck above the existing flat (deal level) deck. This method has the added advantage of providing a vented air space between the insulation

and the roofings which allows dissipation of water vapor.

### **13.3.4 Sheet Metal Eaves Flashing (Strip Shingles)**

Asphalt strip shingle roofing on roof decks with slope of 4 inches per foot or more generally perform well in cold areas. However, wherever there is a possibility of ice forming along the eaves and causing a backup of water, a double cemented felt underlay should be provided over the eaves and extend to a line 24 inches beyond the inside face of the exterior wall. If there is danger of glaciation and ice damage at roof eaves requiring omission of gutters, a metal eaves flashing should be provided. This sheet metal should not be coated or treated in a way which would restrict ice slippage.

### **13.3.5 Provision for Expansion and Contraction**

Allowance should be made for contraction of built-up roofs which are applied during the summer and then subjected to extremely low winter temperatures. Such contraction can cause splitting of felts. Additional expansion joints should be provided. Since glass fiber felts contract more than organic felts, their use should be avoided in arctic areas.

# CHAPTER 14

## SAFETY

### Section I. GENERAL

#### 14.1.1 Introduction

Construction work generally is inherently hazardous. Roof work, whether it be new construction, maintenance or repair, because of its nature, ranks high in the incidence of accidents. While it is true that accidents may occur in spite of measures taken to prevent them, a well-defined program to prevent accidents always pays dividends. Accident prevention is closely tied in with efficiency. The contractor whose equipment is always in order; who attempts to predetermine the hazards of each particular project; and plans accordingly for the prevention of accidents, will not only encounter fewer accidents, but will also operate more efficiently. While this is not intended to be a complete manual on safety precautions in roofing, observance of the following suggestions will go far to prevent common accidents. Good reference works on safety in the construction field are:

(1) "Manual of Accident Prevention in Construction," published by the Associated General Contractors of America, Inc., 1957 E Street, NW Washington, DC 20006.

(2) "American Standard Safety Code for Building Construction," ANSI A10.2-1944, published by the American National Standards Institute, Inc., 1430 Broadway, New York, NY 10018.

(3) General Safety Requirements, EM 385-1-1, 1 March 1970, (Corps of Engineers, US Army).

#### 14.1.2 Storage and Handling of Materials

(1) Segregate materials as to kind and size and place them in neat, orderly piles that are safe against falling. (See instructions under each type of roofing material.)

(2) Place warning signs in daytime and red lights on and around materials stored in walkways or streets at night.

(3) Do not store combustible materials inside of buildings. Cellular plastic roof insulations are combustible unless labeled noncombustible by Underwriters or other acceptable laboratory with

not more than 25 flame spread and 50 smoke generation ratings.

#### 14.1.3 Ladders

(1) Test all ladders to determine whether they are strong enough to carry the intended loads.

(2) Construct wood ladders of straight-grained materials free from defects. Avoid painted ladders since the paint may serve to conceal defects.

(3) Mark metal ladders with signs cautioning against use around electrical equipment.

(4) Provide ladders with nonslip bases and fasten at the top when possible.

(5) Place the foot of a ladder not more than 1/4 its length away from the vertical plane of its top support.

(6) Extend ladders leading to landings or walkways at least 36 inches above the landing and fasten so that they cannot slip. Avoid splicing ladders whenever it is possible.

(7) Construct "chicken" ladders or crawling boards at least 10 inches wide and 1 inch thick, to which are nailed cleats, 1½ inches wide and 1 inch thick, extending the width of the board. The board should extend the full length from the ridge to the eaves and should be fastened securely to the ridge so that it cannot become loose. Make each section of double boards as a single board, with the sections straddling the roof, with the hinge bolt resting on the ridge-pole.

(8) Provide a catch platform or life line on roofs pitched more than 3 inches per foot.

#### 14.1.4 Scaffolds

(1) Design scaffolds to take the maximum loads to which they will be subjected.

(2) Protect the edges of all scaffolds with railings and toe boards.

(3) Do not use scaffolds for the storage of material except that being used currently. Clean scaffolds daily of all rubbish.

(4) Provide a catch or scaffold platform, extending at least 2 feet beyond the eaves and

equipped with a guard rail, on roofs without parapet walls, where the slope is greater than 3 inches per foot and the distance from ground to eaves is more than 20 feet. A life line of manila rope securely fastened to a safe anchorage may be substituted for the platform.

#### **14.1.5 Roof Brackets**

(1) Form triangular roof brackets from three pieces of 2 x 4 inch lumber, with the diagonal member sloped to match the pitch of the roof, and

the horizontal member level to support the roof plank. Many roofers prefer patented metal roof brackets.

(2) Support roof brackets by ropes fastened to a hook securely hooked over the ridgepole of the roof, or to roof members on the other slope of the roof, or by means of pointed projectors driven their full length into the roof framing or deck. Metal roof brackets are generally fastened by 8d or larger nails driven through a slot in the bracket and into a roof rafter.

## **Section II. HEATING AND HANDLING BITUMINOUS MATERIALS**

### **14.2.1 General**

Mount heating kettles on firm, level, noncombustible foundations. Keep them at least 3 feet from any combustible materials, and keep one or more suitable fire extinguishers within 50 feet of each kettle. See that kettles in use are constantly attended and adequately protected from personnel, vehicles, and other equipment. Each kettle should be provided with a closefitting lid which can be closed at once if the heated material flames.

### **14.2.2 Precautions**

The following precautions should be observed when operating bituminous heating kettles:

(1) Material must be thoroughly dry before it is added to heated contents of kettles. Add material

by sliding it into kettles, not by dropping it.

(2) Do not add any inflammable substance to thin or dilute material being heated. Shut down kettle burners when refueling and if heated material bursts into flame.

(3) In handling hot substances, use hoisting gear heavy enough for the loads imposed. Brace all gear securely. In hoisting and handling hot substances, be careful not to endanger workmen nearby or below.

(4) Require all persons handling hot substances to use proper foot and leg protection, gloves, goggles, and any other necessary personal protective equipment.

(5) Do not permit workmen to stand under swinging loads.

## **Section III. SHEET METAL WORKING**

## **Section IV. FIRE PREVENTION AND OTHER SHOP PRECAUTIONS**

### **14.3.1 Tools and Equipment**

The tools and equipment used in handling and working sheet metal are dangerous because of the nature of the work and should not be used by inexperienced personnel. Sheet metal itself is dangerous because of its physical properties and chemical composition. The edges and corners can easily inflict injuries, and many metals or their protective coatings are toxic and can cause serious infections or blood poisoning. Fumes generated by the burning of flux and protective coatings during soldering, welding, and cutting operation are often toxic. Some safety precautions are illustrated in figure 56.

### **14.3.2 Precautions**

The following precautions should be observed when operating equipment and working with sheet metal:

(1) Jewelry and loose clothing should not be worn.

(2) Goggles and gloves should be worn during welding and grinding operations.

(3) Treat all cuts, scratches, and burns immediately to prevent infection and possible blood poisoning.

(4) Protect uncovered skin when handling acids. When diluting acids, always pour acid into water, never water into acid. Keep acids in closed, sealed, clearly-labeled containers.

(5) Power tools should only be operated by experienced personnel.

(6) Power equipment should have safety guards in place at all times.

(7) Have both hands free when ascending or descending a ladder. Transfer tools and equipment with a rope or similar device.

(8) Use only the safest solvent available for the work to be done.

(9) Welding, soldering, and burning should only be done in well ventilated areas and away from flammable liquids and materials.

# Safety

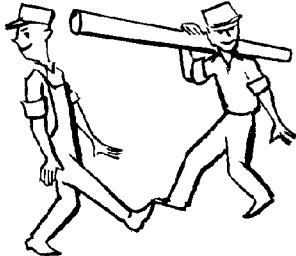

BE ALERT AND PAY ATTENTION TO THE JOB



GET INSTRUCTION HOW TO OPERATE



KEEP SHARP TOOLS OUT OF POCKETS

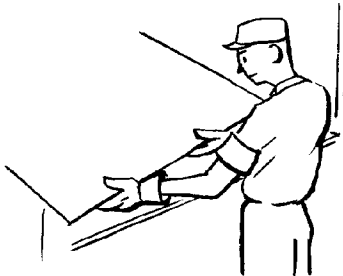

WEAR GLOVES FOR HANDLING SHARP EDGES

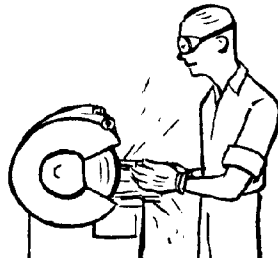

WEAR GOGGLES WHEN NECESSARY

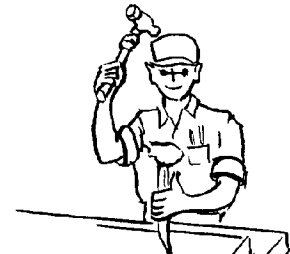

KEEP TOOLS REPAIRED AND DRESSED

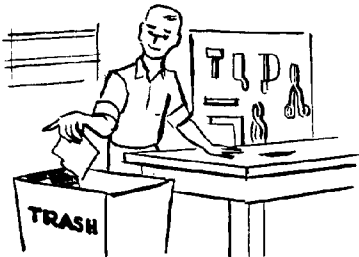

KEEP SHOPS NEAT AND ORDERLY



KEEP FLOORS AND GROUND CLEAR OF TRASH

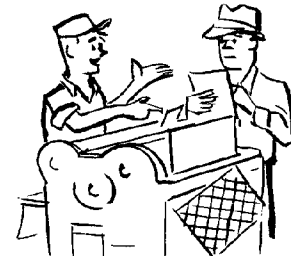

REPORT ALL DANGERS



CLIMB SAFELY



USE SAFETY DEVICES



... AND ALWAYS BE SAFETY CONSCIOUS

Figure 56. Precautions that reduce accidents.

## Section IV. FIRE PREVENTION AND OTHER SHOP PRECAUTIONS

### 14.4.1 General

Workshops by their nature are potential fire and safety hazards. Shop personnel must know and comply with all fire prevention measures as issued by the installation fire marshal. Personnel should be familiar with all available fire fighting apparatus, evacuation procedures, and safety practices.

### 14.4.2 Precautions

The following precautions should be observed at all times:

(1) Flammable liquids must be kept covered when not in use, and when used they must be kept away from fire, flame, and sparks. Fumes from flammable liquids are often toxic and explosive, and their use should be restricted to well-ventilated areas. Wherever possible use nonflammable and nontoxic solvents for cleaning.

(2) Rags contaminated with oil and grease must be cleaned or destroyed daily to prevent spontaneous combustion or accidental ignition.

(3) Machinery and surrounding areas must be kept clean and free of metal shavings and trimming. Oil and grease dripping from

machinery accumulates in dirt and metal filings creating a fire hazard. Metal trimmings and pieces of scrap metal present a safety hazard to personnel.

(4) Tools and equipment should be returned to the racks and containers provided for them. Cluttered work areas increase the working time of a job, subject tools and equipment to abuse, and create a safety hazard.

(5) Provisions should be made for collection and disposal of scrap metal. Adequate bins should be placed near cutting and trimming machines and workbenches.

(6) Gas and gasoline heaters are a constant source of danger. Soldering iron heaters should be turned off when not in use. The odor of gas or gasoline around heaters indicates the presence of a leak. All sources of ignition must be eliminated until the leak is repaired.

(7) Hot soldering irons are a potential fire and safety hazard and must not be placed on flammable materials or where personnel can accidentally come in contact with them. Stands or holders should be provided for hot soldering irons.



## APPENDIX A

### DEPARTMENT OF DEFENSE INSTRUCTIONS

---

4270.1-M

Construction Criteria Manual

4270.21

Guide Specifications for Military Family Housing

## APPENDIX B

### TECHNICAL MANUALS

---

#### **B-1 Department of Defense Tri-Service:**

ARMY TM 5-618	Paints and Protective Coatings.
NAVFAC MO-110	
AIR FORCE AFM 85-3	
ARMY TM 5-785	Army, Navy, and Air Force Manual: Engineering Weather Data.
NAVFAC P-89	
AIR FORCE AFM 88-8,	Chapter 6

#### **B-2. Department of The Army, Department of The Air Force:**

ARMY TM 5-800-1	Construction Criteria for Army Facilities.
ARMY TM 5-805-3	Building Construction Materials and Practices: Roof Decking.
AIR FORCE AFM 88-3	Chapter 9.
ARMY TM 5-805-14	Roofing Design.
AIR FORCE AFM 88-4	Chapter 6.
ARMY TM 5-809-1	Load Assumption for Buildings.
AIR FORCE AFM 88-3	Chapter 1.
ARMY TM 5-809-8	Engineering and Design: Design Criteria for Corrugated Roofing and Siding (Protected Steel).

#### **B-3. Department of The Navy:**

NAVFAC SPECIFICATION 7YK	Roofing and Sheet Metal Work
NAVFAC SPECIFICATION 49Yb	Thermal Insulation for Buildings

## APPENDIX C

### MATERIAL SPECIFICATIONS AND STANDARDS

---

#### American Society for Testing and Materials Standards:

A 167	Corrosion-Resisting, Chromium-Nickel Steel Plate, Sheet and Strip.
B 32	Solder Metal (Tentative).
B 101-	Lead-Coated Copper Sheets.
B 209	Aluminum-Alloy Sheet and Plate.
B 211	Aluminum-Alloy Bars, Rods, and Wire.
B 221	Aluminum-Alloy Extruded Bars, Rods, Shapes, and Tubes.
B 370	Copper Sheet and Strip for Building Construction.
C 208	Structural Insulating Board Made from Vegetable Fibers.
C 221	Corrugated Asbestos-Cement Sheets.
C 222	Asbestos-Cement Roofing Shingles.
D 41	Primer for Use with Asphalt in Dampproofing and Waterproofing.
D 146	Sampling and Testing Felted and Woven Fabrics Saturated with Bituminous Substances for Use in Waterproofing and Roofing.
D 173	Woven Cotton Fabrics Saturated with Bituminous Substances for Use in Waterproofing.
D 224	Asphalt Roll Roofing Surfaced with Powdered Talc or Mica.
D 226	Asphalt-Saturated Roofing Felt for Use in Waterproofing and in Constructing Built-up Roofs.
D 227	Coal-Tar Saturated Roofing Felt for Use in Waterproofing and in Constructing Built-up Roofs.
D 228	Asphalt Roll Roofing, Cap Sheets, and Shingles.
D 250	Asphalt-Saturated Asbestos Felts for Use in Waterproofing and Constructing Built-up Roofs.
D 312	Asphalt for Use in Constructing Built-up Roof Coverings. Type depending on slope of roof.
D 450	Coal-Tar Pitch for Roofing, Dampproofing, and Waterproofing.
D 517	Asphalt Plank.
D 655	Asphalt-Saturated and Coated Asbestos Felts for Use in Constructing Built-Up Roofs.
D 1227	Asphalt-Base Emulsions for Use as Protective Coatings for Built-up Roofs (Type I).
D 1327	Woven Burlap Fabrics Saturated with Bituminous Substances for Use in Waterproofing.
D 1668	Woven Glass Fabrics Treated with Bituminous Substances for Use in Waterproofing.
D 1863	Mineral Aggregate for Use on Built-up Roofs.
D 1866	Translucency of Mineral Aggregate for Use on Built-up Roofs.
D 2626	Asphalt-Base Sheet for Use in Construction of Built-up Roofs.
D 2823	Asphalt Roof Coatings.
D 2824	Asphalt-Based Aluminum Roof Coatings.
E 96	Water Vapor Transmission of Materials in Sheet Form.

#### Commercial Standards:

CS 31-52	Wood Shingles (Red Cedar, Tidewater Red Cypress, California Redwood).
----------	---

## **Underwriters' Laboratories, Inc., Publications:**

UL 55-B Class "C" Asphalt Organic-Felt Sheet Roofing and Shingles.  
Guide Test Method for Wind-Resistant Shingles.  
Building Materials List.

## **Military Specifications:**

MIL-R-3472 Roof Coating; Asphalt-Base Emulsion.  
MIL-S-6872 Soldering Process, General Specification for.  
MIL-C-11090 Cleaning Compound. Degreasing and Depreserving Solvent, Self-Emulsifying.  
MIL-P-14504 Primer Coating, Pretreatment, One-Package Wash Primer (For Steel, Aluminum, and Magnesium).  
MIL-N-15178 Naptha, Solvent.  
MIL-D-16791 Detergent, General Purpose (Liquid Nonionic).

## **Federal Specifications:**

FF-N-105 Nails, Wire, Brads and Staples.  
HH-C-446 Cloth, Glass, Coated (for Membrane Waterproofing and Built-up Roofing).  
HH-I-526 Insulation Board, Thermal (Mineral Fiber).  
HH-I-529 Insulation Board, Thermal (Mineral Aggregate).  
HH-I-530 Insulation Board, Thermal (Urethane).  
HH-I-551 Insulation Block, Pipe Covering and Boards, Thermal (Cellular Glass).  
HH-R-590 Roofing Felt (Asbestos, Asphalt-Saturated).  
HH-R-595 Roofing Felt, Coal-Tar and Asphalt-Saturated Organic Felts, Rolls.  
LLL-I-535 Insulation Board, Thermal and Insulation Block, Thermal.  
O-F-499 Flux, Brazing, Silver Alloy, Low Melting Point.  
O-F-506 Flux, Soldering, Paste and Liquid.  
QQ-L-201 Lead Sheet.  
QQ-N-281 Nickel-Copper-Alloy Bar, Plate, Rod, Sheet, Strip, Wire, Forgings, Structural and Special Shaped Sections.  
QQ-S-561 Solder, Silver.  
QQ-S-571 Solder, Tin Alloy, Lead-Tin Alloy, and Lead Alloy.  
QQ-S-775 Steel Sheets, Carbon, Zinc-Coated.  
QQ-T-201 Terneplate for Roofing and Roofing Products.  
SS-A-666 Asphalt, Petroleum (Built-up Roofing, Waterproofing and Dampproofing).  
SS-A-694 Asphalt, Petroleum (Coating, Brushing, and Spraying Consistency).  
SS-A-701 Asphalt, Petroleum (Primer, Roofing and Waterproofing).  
SS-B-755 Building Board, Asbestos-Cement: Flat and Corrugated.  
SS-C-153 Cement, Bituminous Plastic Type I with Asphalt-Saturated Felts and Type II with Coal-Tar Saturated Felts.  
SS-C-450 Cloth, Impregnated (Woven Cotton Cloth, Asphalt Impregnated, Coal-Tar Impregnated).  
SS-R-501 Roofing Felt, Asphalt-Prepared, Smooth Surfaced.  
SS-R-620 Roofing Felt, Glass Fiber, Asphalt Coated (For Flashing and Roofing).  
SS-R-630 Roofing Felt (Roll, Asphalt-Prepared, Mineral Surfaced).  
SS-S-291 Shingles: Asbestos-Cement (Roofing).  
SS-S-451 Slate, Roofing.  
TT-C-498 Coating Compound, Bituminous, Solvent Type; Asbestos Filled and Aluminum Pigmented, Low Glare.  
TT-C-598 Calking Compound, Oil and Resin Base Type (For Masonry and Other Structures).  
TT-C-655 Creosote, Technical, Wood Preservative, (For Brush, Spray, or Open Tank Treatment).  
TT-C-1079 Coating Compound, Bituminous, Solvent Type; Asphalt Base and Aluminum Pigmented, Leafing Type.  
TT-P-31 Paint, Oil, Iron-Oxide, Ready-Mixed, Red and Brown.

TT-P-641	Primer, Paint, Zinc dust and Zinc Oxide (For Galvanized Surfaces).
TT-S-227	Sealing Compound, Rubber Base, Two Component (For Calking, Sealing, and Glazing in Building Construction).
TT-S-230	Sealing Compound, Elastomeric Type, Single Component (For Calking, Sealing, and Glazing in Buildings and Other Structures).
TT-S-001543	Sealing Compound; Silicone Rubber Base (For Calking, Sealing and Glazing in Buildings and Other Structures).
TT-S-001657	Sealing Compound-Single Component, Butyl Rubber Based, Solvent Release Type (For Buildings and Other Types of Construction).
TT-T-801	Turpentine, Gum Spirits, Steam Distilled, Sulfate Wood, and Destructively Distilled.
TT-W-571	Wood, Preservation: Treating Practice.
VV-F-800	Fuel Oil, Diesel.
VV-K-211	Kerosene.

## APPENDIX D

### NATIONAL BUREAU OF STANDARDS' PUBLICATIONS

---

7470	The Effect of Insulation on the Durability of a Smooth-Surfaced, Built-up Roof.
7489	Performance Roofing in Puerto Rico.
7831	Solar Heating, Emissive Cooling, and Thermal Movement and Their Effect on the Performance of a Built-Up Roof.
8309	The Effects of Thermal Shrinkage on Built-Up Roofing.
8352	Performance of Roofing on Guam, M.I. and Okinawa, R.I.
8382	Evaluation of New Roofing Systems on Guam, M.I.
8632	A New Approach to Roof System Design.
9356	Thermal Shock Resistance for Bituminous Built-Up Roofing Membranes—Its Relation to Service Life.

## APPENDIX E

### INDUSTRY PUBLICATIONS

---

Mineral Fiber Roof Shingles Application Manual

Mineral Fiber Products Bureau  
509 Madison Avenue  
New York, New York 10022

Manufacture, Selection, and Application of Asphalt Roofing and Siding Products

Asphalt Roofing Manufacturing Association  
757 Third Avenue  
New York, New York 10017

Architectural Sheet Metal Manual

Sheet Metal and Air Conditioning Contractors  
National Association, Incorporated  
1611 North Kent Street, Suite 200  
Arlington, Virginia 22209

Sectional Properties of Corrugated Steel Sheets

American Iron and Steel Institute  
150 East Forty-Second Street  
New York, New York 10017

Aluminum Standards and Data

The Aluminum Association  
420 Lexington Avenue  
New York, New York 10017

A Manual of Roofing Practice

National Roofing Contractor's Association  
1515 North Harlem Avenue  
Oak Park, Illinois 60302

Manual of Built-up Roof Systems, by C. W. Griffin, Jr., P.E. for The American Institute of Architects

McGraw-Hill Book Company  
330 West 42nd Street  
New York, New York 10036

Refrigerated Storage Installations-Publication No.759

National Academy of Sciences  
National Research Council  
Washington, D. C.

## APPENDIX F

### GUIDE SPECIFICATIONS FOR MILITARY CONSTRUCTION

---

#### Corps of Engineers Guide Specifications for Military Construction:

CE-216	Miscellaneous Metal.
CE-220.02	Roofing; Strip Shingles.
CE-220.08	Sheet Metalwork, General.
CE-220.09	Ventilators, Roof; Gravity Type.
CE-220.11	(Thermal Insulation) (And) (Underlayment) for Built-Up Roofing.
CE-220.12	Built-Up Roofing for Application Directly on Decks and on Insulation (or Underlayment).
CE-220.13	Elastomeric Roofing, Fluid Applied for Concrete Roof Decks.
CE-220.15	Elastomeric Roofing, Sheet Applied, for Application Directly on Decks and on Insulation (or Underlayment)
CE-222.01	Roofing and Siding; Corrugated, Protected-Steel.
CE-222.02	Roofing and Siding; Corrugated, Asbestos-Cement.
CE-222.03	Roofing and Siding; Aluminum.
CE-222.04	Roofing and Siding; Corrugated, Zinc-Coated Steel.
CE-222.05	Roofing and Siding; Corrugated, Ceramic-Coated Steel.
CE-222.06	Roofing and Siding; Corrugated, Zinc-Coated Steel with Synthetic-Resin-Paint Coating.
CE-222.07	Roofing and Siding; Preformed, Aluminum-Coated Steel.
CE-235.03	Rough Carpentry..
CE-239	Calking and Sealing.
CE-250	Painting, General.

#### Naval Facilities Engineering Command Specifications:

TS-R6	Corrugated Metal Roofing.
TS-R7	Corrugated Cement-Asbestos Roofing.
TS-R8	Elastomeric Roofing Systems.
TS-R9	Cast-in-Place Gypsum Roof Decks.
TS-5R10	Steel Roof Decks.
7YK	Roofing and Sheet Metal Work.
49YB	Thermal Insulation for Buildings.

#### Department of The Air Force

AFM 88-15	Standard Outline Specification for Air Force Facilities.
-----------	--



## APPENDIX F

### GUIDE SPECIFICATIONS FOR MILITARY CONSTRUCTION

---

#### Corps of Engineers Guide Specifications for Military Construction:

CE-216	Miscellaneous Metal.
CE-220.02	Roofing; Strip Shingles.
CE-220.08	Sheet Metalwork, General.
CE-220.09	Ventilators, Roof; Gravity Type.
CE-220.11	(Thermal Insulation) (And) (Underlayment) for Built-Up Roofing.
CE-220.12	Built-Up Roofing for Application Directly on Decks and on Insulation (or Underlayment).
CE-220.13	Elastomeric Roofing, Fluid Applied for Concrete Roof Decks.
CE-220.15	Elastomeric Roofing, Sheet Applied, for Application Directly on Decks and on Insulation (or Underlayment)
CE-222.01	Roofing and Siding; Corrugated, Protected-Steel.
CE-222.02	Roofing and Siding; Corrugated, Asbestos-Cement.
CE-222.03	Roofing and Siding; Aluminum.
CE-222.04	Roofing and Siding; Corrugated, Zinc-Coated Steel.
CE-222.05	Roofing and Siding; Corrugated, Ceramic-Coated Steel.
CE-222.06	Roofing and Siding; Corrugated, Zinc-Coated Steel with Synthetic-Resin-Paint Coating.
CE-222.07	Roofing and Siding; Preformed, Aluminum-Coated Steel.
CE-235.03	Rough Carpentry..
CE-239	Calking and Sealing.
CE-250	Painting, General.

#### Naval Facilities Engineering Command Specifications:

TS-R6	Corrugated Metal Roofing.
TS-R7	Corrugated Cement-Asbestos Roofing.
TS-R8	Elastomeric Roofing Systems.
TS-R9	Cast-in-Place Gypsum Roof Decks.
TS-5R10	Steel Roof Decks.
7YK	Roofing and Sheet Metal Work.
49YB	Thermal Insulation for Buildings.

#### Department of The Air Force

AFM 88-15	Standard Outline Specification for Air Force Facilities.
-----------	--

## APPENDIX G

### SAMPLE HISTORICAL RECORD FORMATS AND INSPECTION FORMATS

#### HISTORICAL RECORD—BUILT-UP ROOFS

BUILDING NO. \_\_\_\_\_ USED FOR \_\_\_\_\_  
Permanent \_\_\_\_\_ Temporary \_\_\_\_\_ Year Roof was Applied \_\_\_\_\_  
Kind of Roof Deck: Wood \_\_\_\_\_ Concrete slab \_\_\_\_\_ Concrete plank \_\_\_\_\_  
Gypsum slab \_\_\_\_\_ Gypsum plank \_\_\_\_\_ Steel \_\_\_\_\_ Other \_\_\_\_\_  
Slope of Roof: Flat \_\_\_\_\_ In. per foot \_\_\_\_\_  
Area of Roof: Squares \_\_\_\_\_ (one square equals 100 sq ft)  
Type of Built-Up Roof:  
Asphalt: Aggregate Surfaced \_\_\_\_\_ Smooth Surfaced \_\_\_\_\_ Cold Process \_\_\_\_\_  
Coal-Tar Pitch \_\_\_\_\_  
Kind of Surfacing: Slag \_\_\_\_\_ Gravel \_\_\_\_\_ Crushed Stone \_\_\_\_\_  
Promenade tile \_\_\_\_\_ Slate slabs \_\_\_\_\_ Mineral-surfaced cap sheet \_\_\_\_\_  
Smooth-surfaced cap sheet \_\_\_\_\_ Other surfacing (name) \_\_\_\_\_

Number of Plies of Felt: 2 \_\_\_\_\_ 3 \_\_\_\_\_ 4 \_\_\_\_\_ 5 \_\_\_\_\_  
Kind of Felt: Organic (Rag) \_\_\_\_\_ Coated \_\_\_\_\_ Uncoated \_\_\_\_\_  
Glass Fiber \_\_\_\_\_ Asbestos \_\_\_\_\_ Coated \_\_\_\_\_ Uncoated \_\_\_\_\_  
Kind of Base Sheet: \_\_\_\_\_  
Insulation: Yes \_\_\_\_\_ No \_\_\_\_\_ Thickness \_\_\_\_\_  
Type of insulation \_\_\_\_\_  
Where placed \_\_\_\_\_  
Vapor barrier: Yes \_\_\_\_\_ No \_\_\_\_\_ Type of vapor barrier \_\_\_\_\_  
Venting: Yes \_\_\_\_\_ No \_\_\_\_\_ Type \_\_\_\_\_

Flashings:  
Base flashings: Metal \_\_\_\_\_ Kind of metal \_\_\_\_\_  
Composition \_\_\_\_\_ Kind \_\_\_\_\_  
Cant strip: Yes \_\_\_\_\_ No \_\_\_\_\_  
Other (describe) \_\_\_\_\_  
Counter or cap flashings: Yes \_\_\_\_\_ No \_\_\_\_\_  
Through wall: Yes \_\_\_\_\_ No \_\_\_\_\_ Metal \_\_\_\_\_  
Kind of metal \_\_\_\_\_ Composition \_\_\_\_\_ Kind \_\_\_\_\_  
Other (describe) \_\_\_\_\_  
Reglet (describe) \_\_\_\_\_

Previous Maintenance: (Describe briefly with dates)  
Roof membrane: \_\_\_\_\_  
Flashings: \_\_\_\_\_

Previous Repairs: (Describe briefly with dates)  
Roof membrane: \_\_\_\_\_  
Flashings: \_\_\_\_\_

Drainage System:  
Roof drains: \_\_\_\_\_  
Scuppers: \_\_\_\_\_  
Gutters: \_\_\_\_\_  
Downspouts: \_\_\_\_\_

HISTORICAL RECORD—ASPHALT-SHINGLE ROOFS

BUILDING NO. \_\_\_\_\_ USED FOR \_\_\_\_\_

Permanent \_\_\_\_\_ Temporary \_\_\_\_\_ Year Roof was Applied \_\_\_\_\_

Kind of Roof Deck: Sheathing boards \_\_\_\_\_ Thickness, in. \_\_\_\_\_

S.S. \_\_\_\_\_ T & G \_\_\_\_\_ Plywood \_\_\_\_\_ Thickness, in. \_\_\_\_\_

Underlayment: None \_\_\_\_\_ Saturated felt \_\_\_\_\_ Paper \_\_\_\_\_

Asphalt shingles \_\_\_\_\_ Wood shingles \_\_\_\_\_ Other \_\_\_\_\_

Slope of Roof, in. per ft: \_\_\_\_\_ Area of roof, squares \_\_\_\_\_

Type of Shingles:

Square butt strip shingles: Exposure, in. \_\_\_\_\_ Weight \_\_\_\_\_  
per square Thick-butt \_\_\_\_\_ Uniform thickness \_\_\_\_\_

Fire protection class: \_\_\_\_\_

    Tabs cemented: Factory applied adhesive \_\_\_\_\_

    Field applied cement \_\_\_\_\_

    Other: (describe) \_\_\_\_\_

Color of Roofing Granules: \_\_\_\_\_

Flashings:

Valley flashings: Roll roofing \_\_\_\_\_ Asphalt shingles \_\_\_\_\_

    Metal \_\_\_\_\_ Kind of metal \_\_\_\_\_

Drip edge: Roll roofing \_\_\_\_\_ Asphalt shingles \_\_\_\_\_ Metal \_\_\_\_\_

    Kind of metal \_\_\_\_\_

Vent flashings: (Describe) \_\_\_\_\_

    Chimney and wall flashings: Roll roofing \_\_\_\_\_ Metal \_\_\_\_\_

    Kind of metal \_\_\_\_\_

Previous Maintenance: (Describe briefly with dates)

Asphalt shingles: \_\_\_\_\_

Flashings: \_\_\_\_\_

Previous Repairs: (Describe briefly with dates)

Asphalt shingles: \_\_\_\_\_

Flashings: \_\_\_\_\_

Gutters and Downspouts

Type Metal \_\_\_\_\_ Gauge \_\_\_\_\_ Thickness \_\_\_\_\_ Weight \_\_\_\_\_

INSPECTION FORMAT: ANNUAL INSPECTION OF BUILT-UP ROOFS

BUILDING NO. \_\_\_\_\_ DATE OF INSPECTION \_\_\_\_\_

Roofing Membrane

General Appearance: Good \_\_\_\_\_ Fair \_\_\_\_\_ Poor \_\_\_\_\_

Water Tightness: No leaks \_\_\_\_\_ Leaks with long-continued rain \_\_\_\_\_  
Leaks every rain \_\_\_\_\_

Reported Cause of Leaks: Weathering of roofing material \_\_\_\_\_

Faulty material \_\_\_\_\_ Faulty design \_\_\_\_\_ Faulty construction \_\_\_\_\_

Wind damage \_\_\_\_\_ Hail damage \_\_\_\_\_ Traffic on roof \_\_\_\_\_

Other mechanical damage (describe) \_\_\_\_\_

\_\_\_\_\_ Low spots (water ponding) \_\_\_\_\_

Failure of flashings \_\_\_\_\_ Failure of gravel stops \_\_\_\_\_

Other causes (describe) \_\_\_\_\_

Adhesion of Aggregate Surfacing to Bitumen: Good \_\_\_\_\_ Fair \_\_\_\_\_

Poor \_\_\_\_\_

Bare Areas: (Give approximate percentage of total roof area below)

Bituminous coating exposed<sup>1</sup> \_\_\_\_\_ Condition of coating:

Smooth \_\_\_\_\_ Alligatored \_\_\_\_\_ Cracked \_\_\_\_\_ Felt exposed \_\_\_\_\_

Felts disintegrated \_\_\_\_\_ Edges of felts curled \_\_\_\_\_ Blisters \_\_\_\_\_

(Give size range and approximate number per square if numerous) \_\_\_\_\_

Cracked to allow water to enter: Yes \_\_\_\_\_ No \_\_\_\_\_

Buckles \_\_\_\_\_ Cracked to allow water to enter: Yes \_\_\_\_\_ No \_\_\_\_\_

Cracks in membrane \_\_\_\_\_ Through to roof deck: Yes \_\_\_\_\_ No \_\_\_\_\_

Fishmouths \_\_\_\_\_

General Condition of Roof Membrane: \_\_\_\_\_

Treatment Recommended: \_\_\_\_\_

Flashings:

Base Flashings:

Metal:

Deteriorated \_\_\_\_\_ Vertical joints open \_\_\_\_\_ Flanges of base  
metal flashing loose: Yes \_\_\_\_\_ No \_\_\_\_\_ Due to: Inadequate  
nailing \_\_\_\_\_ Not properly sealed with felt strips \_\_\_\_\_

Plastic:

Sagged or separated from parapet wall \_\_\_\_\_ Buckled \_\_\_\_\_  
Cracked \_\_\_\_\_ Failure of base flashing: Weathering \_\_\_\_\_  
Mechanical \_\_\_\_\_ Surface coating disintegrated: Yes \_\_\_\_\_  
No \_\_\_\_\_ Vertical laps not cemented properly: Yes \_\_\_\_\_ No \_\_\_\_\_

Cap Flashings:

Metal:

Firmly embedded into vertical wall: Yes \_\_\_\_\_ No \_\_\_\_\_  
Deteriorated \_\_\_\_\_ Vertical joints open \_\_\_\_\_ Not covering base  
flashing adequately: Yes \_\_\_\_\_ No \_\_\_\_\_

Plastic:

Surface coating disintegrated \_\_\_\_\_ Flashing felt disintegrated \_\_\_\_\_

Flashing Reglet:

Groove pointed sufficiently: Yes \_\_\_\_\_ No \_\_\_\_\_

Recommended Treatment: \_\_\_\_\_

Gravel Stop: Condition of Metals \_\_\_\_\_ Stripped in properly \_\_\_\_\_

Separated from roof membrane \_\_\_\_\_

<sup>1</sup> Surfaced roofs only

Drainage System (describe defects)

Roof drains \_\_\_\_\_  
Scuppers \_\_\_\_\_  
Gutters \_\_\_\_\_  
Downspouts \_\_\_\_\_  
Recommended Treatment: \_\_\_\_\_

Parapet Walls:

Mortar joints deteriorated \_\_\_\_\_ Settlement cracks in walls \_\_\_\_\_  
Joints in tile coping open \_\_\_\_\_ Concrete coping cracked \_\_\_\_\_  
Other defects (describe) \_\_\_\_\_  
Recommended Treatment: \_\_\_\_\_

## INSPECTION FORMAT: ANNUAL INSPECTION OF ASPHALT-SHINGLE ROOFS

Note. Asphalt-shingle roofs should never be walked upon directly. When it is necessary to get on a roof, ladders or boards with cleats nailed to them should be used to distribute the weight.

BUILDING NO. \_\_\_\_\_ DATE OF INSPECTION \_\_\_\_\_  
Asphalt Shingles

General Appearance: Good \_\_\_\_\_ Fair \_\_\_\_\_ Poor \_\_\_\_\_

Water Tightness: No leaks \_\_\_\_\_ Leaks with long-continued rain \_\_\_\_\_  
Leaks every rain \_\_\_\_\_

Reported Cause of Leaks: Weathering of shingles \_\_\_\_\_

Faulty material \_\_\_\_\_ Faulty design \_\_\_\_\_ Wind Damage \_\_\_\_\_

Faulty application: a. Nailed too high \_\_\_\_\_ b. Too few nails \_\_\_\_\_  
c. Exposure too great \_\_\_\_\_

Hail damage \_\_\_\_\_ Traffic on roof \_\_\_\_\_ Other mechanical damage (describe) \_\_\_\_\_

Failure of flashings \_\_\_\_\_ Where \_\_\_\_\_

Other causes (describe) \_\_\_\_\_

Condition of Shingles: Apparently unchanged \_\_\_\_\_ Buckled \_\_\_\_\_

Blistered \_\_\_\_\_ Loss of Granules: Slight \_\_\_\_\_ Medium \_\_\_\_\_

Severe (bare areas) \_\_\_\_\_ Curled \_\_\_\_\_ Tabs Missing \_\_\_\_\_

Asphalt coating damaged (hail, etc.) \_\_\_\_\_ Coating alligatored or  
 cracked \_\_\_\_\_ Other defects (describe) \_\_\_\_\_

General Condition of Asphalt-Shingle Roof: \_\_\_\_\_

Treatment Recommended: \_\_\_\_\_

Flashings: (Describe condition if defective.)

Chimney flashings:	Satisfactory _____	Defective _____
Wall flashings:	Satisfactory _____	Defective _____
Ridge flashings:	Satisfactory _____	Defective _____
Vent flashings:	Satisfactory _____	Defective _____
Valley flashings:	Satisfactory _____	Defective _____
Edge flashings:	Satisfactory _____	Defective _____

Drainage System: (Describe condition if defective.)

Gutters:	Satisfactory _____	Defective _____
Downspouts:	Satisfactory _____	Defective _____

Treatment Recommended: \_\_\_\_\_

# INDEX

	Paragraph	Page
Aggregate surfacing .....	4.1.5, 4.3.4	19
Access to roofs .....	1.1.10	2
Aluminum roofing .....	11.4.4	72
Maintenance .....	11.4.4.8	72
Repair .....	11.4.4.9	72
Reroofing .....	11.4.4.10	72
Application, improper (See Improper application) .....	3.1.5	6
Asbestos-cement roofing:		
American method shingles .....	7.1.2.2	47
Corrugated sheets .....	7.1.2.6	47
Description and general discussion .....	7.1	47
Dutch lap shingles .....	7.1.2.3	47
Fire resistance .....	7.1.3	48
Hexagonal shingles .....	7.1.2.4	47
Maintenance and repair .....	7.5	49
Multiple unit shingles .....	7.1.2.5	47
Reroofing .....	7.6	49
Roof decks for .....	7.2	48
Storage and handling .....	7.3	48
Treatment, determining .....	7.4	48
Asphalt .....		
Description .....	4.1.3, 4.1.3.2	14
Storage and handling .....	4.3.2	18
Temperature .....	4.3.2.1	18
Application .....	4.3.2.2	18
Asphalt roll roofing:		
Description and general discussion .....	6.1	41
Fire resistance .....	6.1.4	43
Maintenance .....	6.5	43
Mineral-surfaced .....	6.1.3	41
Repair .....	6.6	44
Reroofing .....	6.7	46
Roof decks .....	6.2	43
Smooth-surfaced .....	6.1.2	41
Storage and handling .....	6.3	43
Treatment, determining .....	6.4	43
Wide-selvage .....	6.1.3	41
Asphalt strip shingles:		
Application .....	5.6.3	39
Description and general discussion .....	5.1	31
Fire resistance .....	5.1.7	31
Head lap .....	5.1.5	31
Maintenance and repair .....	5.5	36
Recoating .....	5.4.3	34
Reroofing .....	5.6	39
Roof decks for .....	5.2	33
Storage and handling .....	5.3	33
Treatment for .....	5.4	33
Wind-resistant .....	5.1.9, 5.6.3.5	32, 40
Weight .....	5.1.4	31
Batten-seam roofing .....	11.1.5.1.1	61
Bitumen .....	4.1.3	14
Blisters or buckles .....	4.5.2.2, 4.5.3.2, 4.6.1.3	22, 26
Built-up roofing:		
Aggregate-surfaced .....	4.1.5, 4.5.2, 4.6.1	15, 21, 25
Descriptions and general discussion .....	4.1	14
Maintenance methods .....	4.5	21

	Paragraph	Page
Repair methods .....	4.6	25
Reroofing .....	4.7	29
Roof decks .....	4.2	17
Smooth-Surfaced .....	4.16 4.5.3, 4.6.2	15, 22, 29
Storage, handling, and application of materials .....	4.3	18
Treatment, determining .....	4.4	21
Cant strip .....	4.3.3.2	19
Causes of roof failures		
Exposed nails .....	3.1.8	12
Failure of flashings .....	3.1.9	12
Improper application of roofing materials .....	3.1.5	6
Improper design .....	3.1.10	13
Improper storage .....	3.1.4	6
Lack of maintenance .....	3.1.1	6
Use of improper materials .....	3.1.6	9
Use of unseasoned lumber or improper grade plywood .....	3.1.3	6
Weathering .....	3.1.2	6
Wall, chimney, and monitor flashings .....	12.1.1.1	76
Wind damage .....	3.1.7	12
Clawed asphalt strip shingles .....	5.4.2	33
Coal-tar pitch		
Application .....	4.3.2.2	18
Discussion .....	4.1.3, 4.1.3.1	14
Storage and handling .....	4.3.2	18
Temperature .....	4.3.2.1	18
Compatibility of bitumen .....	4.5.1	21
Copper roofing .....	11.4.1	69
Maintenance .....	11.4.1.7	69
Repair .....	11.4.1.8, 11.4.1.9	69
Reroofing .....	11.4.1.10	70
Corrosion-resisting steel (See Stainless steel)		
Corrugated roofing		
Asbestos-cement .....	7.1.2.6	47
Metal .....	11.1.5.2	62
Curb type flashing .....	12.2.1, 12.6	80, 88
Decks, roof:		
Asbestos-cement roofing .....	7.2	48
Asphalt roll roofing .....	6.2	43
Asphalt strip shingles .....	5.2	33
Built-up roofing .....	4.2	17
Metal roofing .....	11.2	68
Slate roofing .....	8.2	51
Tile roofing .....	9.2	54
Wood shingle roofing .....	10.2	57
Design deficiencies .....	4.7.5	30
Design, improper .....	3.1.10	13
Determining treatment (See Treatment, determining)		
Drainage, roof .....	3.1.6, 4.1.11	9, 17
Drainage systems .....	12.4	83
General .....	12.4.1	83
Check list .....	12.4.2	84
Maintenance and repair .....	12.4.3	85
Drawings, contract .....	4.7.3	29
Drip edge .....	5.5.4, 5.5.5	37
Dripping of bitumen, preventing .....	12.5.3.4, 4.3.3.2	86, 19
Eaves flashing for asphalt strip shingles .....	5.6.3.3	40
Elastomeric roofing .....	13.1	89
Emulsion, asphalt .....	4.3.2.2, 4.5.3.3.2	18, 24
Expansion and contraction		
Aluminum .....	11.4.4.2	72
General .....	11.1.2	60
Stainless steel .....	11.4.5.4	3
Terne .....	11.4.2.2	70
Fasteners, seams and joints:		
Aluminum .....	11.4.4.7	72
Copper .....	11.4.1.5	69
Galvanized iron .....	11.4.3.4	71



	Paragraph	Page
Stainless steel .....	11.4.5.7	73
Terne .....	11.4.2.4	70
Fastening, built-up roofing .....	4.1.10	17
Felts, roofing .....	4.1.4	14
Application .....	4.3.3.2	19
Storage .....	4.3.3.1	19
Fire classification for roof coverings .....	1.1.5	1
Asbestos-cement roofing .....	7.1.3	48
Asphalt roll roofing .....	6.1.4	43
Asphalt strip shingle roofing .....	5.1.7	31
Slate roofing .....	8.1.4	51
Fire precautions		
Heating and handling bituminous materials .....	14.2.2	92
In shops .....	14.4.2	94
Fishmouths .....	4.6.1.4	27
Flashings and Appurtenances:		
Curb type flashing .....	12.2.1,12.6	80, 88
Drainage systems .....	12.4	83
Gravel stops and metal edging .....	12.5	86
Projections thru roof .....	12.6	88
Valley flashings .....	12.3	82
Vent flashings (ventilators, plumbing stacks, etc) .....	12.2	80
Wall, chimney, and monitor flashings .....	12.1	76
Flashings, failure of .....	3.1.9	12
Flashings, strip shingles .....	5.6.3.3, 5.6.3.4	40
Flat seam metal roofing .....	11.1.5.1.3	62
Flux, soldering .....	11.1.7.2	65
Galvanic action:		
Aluminum .....	11.4.4.3	72
Copper .....	11.4.1.4	69
General .....	11.1.3	60
Galvanized steel roofing .....	11.4.3	71
Maintenance .....	11.4.3.5	71
Repair .....	11.4.3.6	71
Gravel stops		
General .....	12.5.1	86
Inspection .....	12.5.2	86
Maintenance and repair .....	12.5.3	86
Guide specifications, use of .....	4.7.2, 11.12	29,2
Gutters and leaders .....	12.4.2, 12.4.3.2	84, 85
Hail damage, asphalt strip shingles .....	5.5.1	:36
Handling (See Storage and handling)		
Improper application .....	3.1.5	6
Asphalt roll roofing .....	5.3	8
Asphalt shingle roofing .....	3.1.5.4	
Built-up roofing .....	3.1.5.2	6
Metal roofing .....	3.1.5.5	9
Rigid roofing materials (Slate, tile, asbestos-cement) .....	3.1.5.6	9
Inspection, importance of .....	2.1	4
Contract .....	2.1.3	4
Periodic .....	2.1.1	4
Special .....	2.1.2	4
Insulation, built-up roofing .....	4.1.7	16
Storage .....	4.3.5.1	20
Application .....	4.3.5.2	20
Ladders .....	14.1.3	91
Lead-coated copper .....	11.4.1.1.2	69
Maintenance:		
Aluminum roofing .....	11.4.4.8	72
Asbestos-cement roofing .....	7.5	49
Asphalt roll roofing .....	6.5	43
Asphalt shingle roofing .....	5.5	36
Built-up roofing .....	4.5	21
Copper roofing .....	11.4.1.7	69
Drainage systems .....	12.4.3	85

	Paragraph	Page
Galvanized steel roofing .....	11.4.3.5	71
General .....	2.1.4	
Gravel stop and metal edging .....	12.5.3	86
Slate roofing .....	8.5	52
Stainless steel roofing .....	11.4.5.8	7:1
Terne roofing .....	11.4.2.5	70
Tile roofing .....	9.5	56
Valley flashings .....	12.3.3	82
Vent (Ventilator, plumbing stack, etc (flashings) .....	12.2.3	81
Wall, chimney and monitor flashings .....	12.1.3	78
Wood shingle .....	10.5	58
Metal roofing:		
Aluminum roofing .....	11.4.4	72
Copperroofing .....	11.4.1	69
Description and general discussion .....	11.1	60
Expansion and contraction .....	11.1.2	60
Fire protection .....	11.1.6	6:1
Galvanic actron .....	11.1.3	60
Galvanized metal roofing .....	11.4.3	71
Protected metal roofing .....	11.4.6	73
Safety precautions .....	14.3	92
Soldering .....	11.1.7	63
Stainless steel roofing .....	11.4.5	72
Storage and handling .....	11.3	68
Terne .....	11.4.2	70
Workability .....	11.1.4	69
Mission tile (See Tile Roofing).		
Nailing, asphalt strip shingles .....	5.5.1	36
Nail popping .....	4.2.1	17
Painting:		
Aluminum .....	11.4.4.6	72
Metal valleys .....	12.3.2.1	82
Terne .....	11.4.2.1.3	70
Parapet walls .....	2.1.2(2), 4.4, 12.1, 12.1.3.6	4, 21, 76, 80
Patina .....	11.4.1.1.1	69
Promenade tile .....	9.1.3, 9.2.2, 9.4.2, 9.5.2	54, 55, 56
Recoating:		
Asphalt roll roofing .....	6.5	43
Asphalt strip shingles .....	5.4.3	34
Smooth surfaced built-up roofs .....	4.5.3	22
Repair:		
Aluminum roofing .....	11.4.4.9	72
Asbestos-cement roofing .....	7.5	49
Asphalt roll roofing .....	6.6	44
Asphalt shingle roofing .....	5.5	36
Built-up roofing .....	4.6	25
Copper roofing .....	11.4.1.8, 11.4.1.9	69
Drainage systems .....	12.4.3	85
Galvanized steel roofing .....	11.4.3.6	71
General .....	2.1.5	5
Gravel stops and metal edging .....	12.5.3	86
Slate roofing .....	8.5	52
Stainless steel roofing .....	11.4.5.9	73
Terne roofing .....	11.4.2.6	70
Tile roofing .....	9.5	56
Valley flashings .....	12.3.3	82
Vent (Ventilator, plumbing stack, etc.) flashings .....	12.2.4	81
Wall, chimney and monitor flashings .....	12.1.3	78
Wood shingle roofing .....	10.5	58
Replacing individual slates .....	8.5.2	52
Reroofing:		
Aluminum roofing .....	11.4.4.10	72
Asbestos-cement roofing .....	7.6	49
Asphalt shingle roofing .....	5.6	39
Built-up roofing .....	4.7	29
Copper roofing .....	11.4.1.10	70
Galvanized steel roofing .....	11.4.3.7	71
General .....	2.1.6	5

	Paragraph	Page
Slate roofing .....	8.6	53
Stainless steel roofing .....	11.4.5.10	73
Theme roofing .....	11.4.2.7	70
Tile roofing .....	9.6	56
Vent (Ventilator, plumbing stack, etc.) flashings .....	12.2.4	81
Wall, chimney and monitor flashings .....	12.1.4	80
Wood shingle roofing .....	10.6	59
Research on roofing .....	2.1.7	5
Responsibility:		
Department of the Air Force .....	1.4	3
Department of the Army .....	1.2.1, 1.2.2	2
Department of the Navy .....	1.3.1, 1.3.2	2
Roll roofing (See Asphalt roll roofing)		
Safety:		
Asphalt and coal-tar pitch .....	4.3.2	18
Fire precautions in shops .....	14.4.2	94
General discussion .....	14.1.1	91
Heating and handling bituminous materials .....	14.2.1	92
Ladders .....	14.1.3	91
Roof brackets .....	14.1.5	92
Scaffolds .....	14.1.4	91
Sheet metal .....	14.3.1	92
Storage and handling of materials .....	14.1.2	91
Scaffolds .....	14.1.4	91
Shingles (see each type)		
Slate roofing:		
Description and general discussion .....	8.1	51
Fire resistance rating .....	8.1.4	51
Maintenance and repair .....	8.5	52
Reroofing .....	8.6	53
Storage and handling .....	8.3	52
Slope, recommended roof .....	3.1.6	9
built up roofs .....	4.1.2	14
Smooth-surfaced built-up roofing .....	4.1.6, 4.5.3	15, 22
Soldering .....	11.1.7, 11.4.5.6	63, 73
Spanish tile (See Tile roofing)		
Special roofings:		
Bare concrete roofs-tropical areas .....	13.2	89
Elastomeric roofing .....	13.1	89
Reroofing in arctic areas .....	13.3	89
Specifications .....	1.1.12, 4.7.2	2, 29
Specifications and standards (app C)		
Specifications, Guide (app F)		
Splits .....	4.6.1.2	25
Standing seam roofing .....	11.1.5.1.2	61
Stainless steel roofing .....	11.4.5	72
Storage and handling:		
Asbestos-cement roofing .....	7.3	48
Asphalt roll roofing .....	6.3	43
Asphalt shingle roofing .....	5.3	33
Heating and handling of bituminous materials .....	4.3.2, 14.2.1	18, 92
Metal roofing .....	11.3	68
Safety .....	14.1.2	91
Tile .....	9.3	54
wood shingles .....	10.3	58
Storage, improper .....	3.1.4	6
Surfacing:		
Aggregate .....	4.1.5	15
Embedment of .....	4.3.4	19
Temper .....	11.4.1.2, 11.4.2.3,	69, 70, 71, 72
Terne roofing:	11.4.3.3, 11.4.4.4	
General .....	11.4.2.1	70
Maintenance .....	11.4.2.5	70
Repair .....	11.4.2.6	70
Thickness of sheet metals (table 3 and table 5) .....	11.1.8	68, 75
Tile roofing:		
Description and general discussion .....	9.1	54
Fire classification .....	9.1.5	54
Maintenance and repair .....	9.5	56

	Paragraph	Page
Reroofing .....	9.6	56
Storage and handling .....	9.3	54
Treatment, determining:		
Asbestos-cement roofing .....	7.4	48
Asphalt roll roofing .....	6.4	43
Asphalt shingle roofing .....	5.4.1	33
Built-up roofing .....	4.4	21
Metal roofing .....	11.4	69
Slate roofing .....	8.4	52
Tile roofing .....	9.4	55
Wood shingle roofing .....	10.4	58
Underlayment for built-up roofing (See Insulation)		
Valley flashing:		
Asphalt strip shingles .....	5.6.3.4	40
Failure .....	12.3.2	
Maintenance and repair .....	12.3.3	82
Metal .....	12.3.1.1	82
Roll roofing .....	12.3.1.2	82
Woven asphalt strip shingle .....	12.3.1.3	82
Vapor barrier .....	4.1.8, 4.3.6	17, 21
Vent (Ventilators, plumbing stacks, etc.) flashings:		
Failures .....	12.2.2	80
General discussion .....	12.2.1	80
Maintenance .....	12.2.3	81
Repair during reroofing .....	12.2.4	81
Venting built-up roofs .....	4.1.9	17
Walkways .....	1.1.10	9
Wall, chimney, and monitor flashings		
Base flashing .....	12.1	7(3)
	12.1.1.2.1(1), 12.1.2.1,	76, 77, 78
	12.1.2.2, 12.1.3.1	
	12.1.3.2	
Cap flashing .....	12.1.1.2.1(2), 12.1.2.3, 76, 77, 78, 79	
	12.1.2.4, 12.1.3.3	
	12.1.3.4	
Causes of failure .....	12.1.1.1	76
Maintenance and repair .....	12.1.3	78
Weathering:		
Asphalt strip shingles .....	5.4.1	33
Cause of roof failure .....	3.1.2	6
Weather conditions .....	4.3.1	18
Wind damage .....	3.1.7	12
Wind-resistant strip shingles .....	5.1.9, 5.6.3.5	32, 40
Wood shingle roofing .....	10.0	57
Workability of metal .....	11.1.4, 11.4.1.3,	69, 72, 73
	11.4.4.5, 11.4.5.5	

By Order of the Secretaries of the Army, the Navy, and the Air Force:

Official:

VERNE L. BOWERS,  
Major General, United States Army,  
*The Adjutant General.*

CREIGHTON W. ABRAMS,  
*General United States Army,*  
*Chief of Staff.*

A. R. MARSCHALL  
*Rear Admiral, CEC, US Navy*  
*Commander, Naval Facilities,*  
*Engineering Command.*

Official:

JACK R. BENSON, *Colonel, USAF*  
*Director of Administration.*

GEORGE S. BROWN, *General, USAF*  
*Chief of Staff.*

HARRY C. OLSON  
*Major General, US Marine Corps*  
*Quartermaster General of the Marine Corps..*

Distribution:

Active Army:

To be distributed in accordance with DA Form 12-34 (qty rqr block no. 92) requirements for TM 5-600 Series: Facilities Engineering: Maintenance and Operation of Facilities.

NG and USAR: None

Navy: SNDL

Distribution: (5 copies unless otherwise indicated)

E3A (Washington only), FA6 (less Key West, Norfolk, and Guantanamo), FA7, FA10, FA18, FA23, (Antigua, Barbados, Buxton, Eleuthera, Lewes, Nantucket, and Turks Island only), FA25, FA27; FB6, FB7, FB10, FB13, FB21, FB26, FB34 (Sasebo only), FB36 (Big Sur, Coos Head, Ferndale, and Pacific Beach only); FC3 (London only), FC4 (Naples and Sigonella only), FC5, FC7; FE2 FE4 (Ft. George G. Meade, Edzell, Homestead, Marietta, Galeta Island, and Winter Harbor only); FF4, FF6, FF19; FG2 (Adak, Asmara, Cheltenham, Diego Garcia, Londonderry, Morocco, Iceland, Nea Makri, Harold E. Holt, Ponce, P.R., San Francisco, and Wahiawa only), FGS (East Machias, Oso, and Thurso only); FG11; FH3 Hospitals (Beaufort, Camp Pendleton, Oakland, Orlando, Philadelphia, Portsmouth, Va., and St. Albans only), FH6 (Bethesda only) FH8 (Cairo only); FJ5, FJ52; FKA6A1, FKA6A2, FKA6A3A, FKA6A3B, FKA6A4, FKA6A8, FKA6A9, FKA6A11, FKA6A14, FKA6A1S, FKL1, FEL6 (Orange only); FKM3, FKM8, FKM9 (Oakland only), FKM13, FKM22; FKN1 (35 copies), FKN2, FKN3, FKNS, FKN1O, FKP1A, FKP1B, FKP1E, FKP1J, FKP4C, FKR1A, FKR3A, FKR3H, FKR5; FR3; FT6, FT22 (Dam Neck, Va. only), FT31, FTSS, FT64, FT68, FT69, FT70

Copy to: (2 copies unless otherwise indicated)

21A, A2A (ONR only); A3 (OP-44 only), A4A (MAT only), AS, A6 (10 copies); FA1; FE1; FF1; FGI; FKA1, FKR3J, FKR6A; FR1, FR2, FR7; FT1, FT2, FT3, FTS, FT37 (30 copies), FT42 (5 copies); V3, VS, V8, V9, V12, V16

Additional copies may be obtained from:

U.S. Naval Publications and Forms Center  
5801 Tabor Avenue  
Philadelphia, PA 19120

Marine Corps:

MARCORPS CODES: 3700009 (18)  
3700001 (16)  
7315001(14)  
6025002 (12)  
3700002, 003 (10)  
7256040 (7)  
7315002 (6)  
2005002/2020002/6901 (5)  
2020004, 005, 006, 007/3700004, 005/6025001/ 6600002 (4)  
2020001, 008, 009/3550001,19508110 (3)  
1080006/2020003, 010/2030002/3520028/3700006, 008/ 4090005/6902003/7230004/72560 19/7401(2)  
1070015, 021/2157010/2161002/2170001/3001001/3510016/3520004, 005, 006, 013, 015, 018, 021, 023,  
026/3530001/3540005/4125003/4185001/4238003/6025003/7352018/7504003. 010, 019, 022,  
68115, 120, 128, 133, 138/7777008/7781004, 008, 508111, 113, 114, 115, 116,  
117/954001 (1)

It is requested that bulk shipments be made as follows:

Commanding General 390 copies  
Marine Corps Supply Center  
Albany, Georgia 31704  
(MIF PUBS STOCK MAX)  
Commandant of the Marine Corps 60 copies  
(Code ABP-2C, Room 1304)  
Arlington Annex  
Washington, D. C. 20380

Air Force: F

